

DCD-PRO600

Professional Dual CD Player



Featuring:



AMERICAN AUDIO

4295 Charter Street

Los Angeles Ca. 90058

www.americandj.com

Revised 2/03

CONTENTS

CAUTIONS REGARDING HANDLING.....	3
PRODUCT INFORMATION.....	5
CUSTOMER SUPPORT	6
SET-UP.....	6
FEATURES.....	7
FUNCTIONS AND CONTROLS	
REMOTE UNIT.....	8
PLAYER UNIT.....	12
LIQUID CRYSTAL DISPLAY.....	14
BASIC OPERATION	
LOADING/EJECTING DISC.....	16
SELECTING TRACKS.....	16
STARTING/STOPPING PLAYBACK.....	16
FRAME SEARCH.....	17
ADJUSTING TIME DISPLAY.....	17
MAKING PITCH CHANGES	18
SETTING CUE POINTS.....	20
CREATING SEAMLESS LOOPS.....	21
EDITING LOOPS.....	22
PROGRAMMING AND PROGRAM PLAY.....	23
ADVANCED OPERATION	
CREATING A BOP EFFECT.....	24
REVERSE PLAY.....	24
FLIP-FLOP.....	25
USING THE BUILT-IN EFFECTS	
SCRATCH.....	26
COAST.....	26
FILTER.....	27
CHANGING EFFECT PARAMETERS.....	27
OPTIONAL SCRATCH BOX SET-UP.....	28
SHUT DOWN PROCEDURES.....	29
HANDLING COMPACT DISC.....	29
WARRANTY.....	30
SPECIFICATIONS.....	31

Please Note: All specifications and improvements to and in the design of this unit and this manuals are subject to change at any time without any prior written or published noticed.

ELECTRICAL SAFETY PRECAUTIONS

NOTE: This CD player uses a semiconductor laser. It is recommended for use in a room at the following temperature: 41°F - 95°F / 5°C - 35°C

CAUTION:

1. Handle the power supply cord carefully. Do not damage or deform; it may cause electric shock or malfunction when used. Hold plug attachment when removing from wall outlet. Do not pull on the cord.
2. To avoid electric shock, do not open the top cover when the unit is plugged in. If problems occur with the unit, call your local American Audio® dealer.
3. Do not place metal objects or spill liquid inside the CD player. Electric shock or malfunction may occur.

The serial and model number for this unit is located on the rear panel. Please write down the numbers here and retain for future reference.

Model No. _____

Serial No. _____

NOTE: This product satisfies FCC regulations when shielded cables and connectors are used to connect the unit to other equipment. To prevent electromagnetic interference with electrical appliances such as radios and televisions, use shielded cables and connectors for connections.

CAUTION:

USE OF CONTROLS OR ADJUSTMENTS OTHER THAN THOSE SPECIFIED HEREIN MAY RESULT IN HAZARDOUS RADIATION EXPOSURE

THE COMPACT DISC PLAYER SHOULD NOT BE ADJUSTED OR REPAIRED BY ANYONE EXCEPT PROPERLY QUALIFIED SERVICE PERSONNEL.

CAUTION: TO PREVENT ELECTRIC SHOCK DO NOT USE THIS (POLARIZED) PLUG WITH AN EXTENSION CORD, RECEPTACLE, OR OTHER OUTLET UNLESS THE BLADES CAN BE CAREFULLY INSERTED TO PREVENT BLADE EXPOSURE

ATTENTION: POUR PREVENIR LES CHOCS ELECTRIQUES NE PAS UTILISER CETTE FICHE POLARISEE AVEC UN PROLONGATEUR, UNE PRISE DE COURANT OU UNE AUTRE SORTIE DE COURANT, SAUF SI LES LAMES PEUVENT ETRE INSEREES A FOND SANS EN LAISSER AUCUNE PARTIE A DECOUVERT.

WARNING: TO PREVENT FIRE OR SHOCK HAZARD, DO NOT EXPOSE THIS UNIT TO WATER OR MOISTURE

This equipment has been tested and found to comply with the limits for a Class B digital device, pursuant to Part 15 of the FCC Rules. These limits are designed to provide reasonable protection against harmful interference in a residential installation. This equipment generates, uses, and can radiate radio frequency energy and, if not installed and used in accordance with the instructions, may cause harmful interference to radio communications. However, there is no guarantee that interference will not occur in a particular installation. If this equipment does cause harmful interference to radio or television reception, which can be determined by turning the equipment off and on, the user is encouraged to try to correct the interference by one or more of the following measures:

- Reorient or relocate the receiving antenna.
- Increase the separation between the equipment and receiver.
- Connect the unit into an electrical outlet on a circuit different from that to which the receiver is connected.
- Consult the dealer or an experienced radio/TV technician for help.

ELECTRICAL SAFETY PRECAUTIONS

ELECTRICAL PRECAUTIONS



The lightning flash with arrowhead symbol, within an equilateral triangle, is intended to alert the user to the presence of uninsulated "dangerous voltage" within the product's enclosure that may be of sufficient magnitude to constitute a risk of electric shock to persons.



CAUTION: TO REDUCE THE RISK OF ELECTRIC SHOCK, DO NOT REMOVE THE COVER (OR BACK). THERE ARE NO USER SERVICEABLE PARTS INSIDE. REFER SERVICE TO YOUR AUTHORIZED AMERICAN AUDIO® SERVICE TECHNICIAN.



The exclamation point within an equilateral triangle is intended to alert the user to the presence of important operating and maintenance (servicing) instructions in the literature accompanying the appliance.

IMPORTANT SAFETY INSTRUCTIONS

READ INSTRUCTIONS — All the safety and operating instructions should be read before the product is operated.

RETAIN INSTRUCTIONS — The safety and operating instructions should be retained for future reference.

HEED WARNINGS — All warnings on the product and in the operating instructions should be adhered to.

FOLLOW INSTRUCTIONS — All operating and use instructions should be followed.

CLEANING — The product should be cleaned only with a polishing cloth or a soft dry cloth. Never clean with furniture wax, benzine, insecticides or other volatile liquids since they may corrode the cabinet.

ATTACHMENTS — Do not use attachments not recommended by the product manufacturer as they may cause hazards.

WATER AND MOISTURE — Do not use this product near water — for example, near a bathtub, wash bowl, kitchen sink, or laundry tub; in a wet basement; or near a swimming pool; and the like.

ACCESSORIES — Do not place this product on an unstable cart, stand, tripod, bracket, or table. The product may fall, causing serious injury to a child or adult, and serious damage to the product. Use only with a cart, stand, tripod, bracket, or table recommended by the manufacturer, or sold with the product. Any mounting of the product should follow the manufacturer's instructions, and should use a mounting accessory recommended by the manufacturer.

CART — A product and cart combination should be moved with care. Quick stops, excessive force, and uneven surfaces may cause the product and cart combination to overturn.



VENTILATION — Slots and openings in the cabinet are provided for ventilation and to ensure reliable operation of the product and to protect it from overheating, and these openings must not be blocked or covered. The openings should never be blocked by placing the product on a bed, sofa, rug, or other similar surface. This product should not be placed in a built-in installation such as a bookcase or rack unless proper ventilation is provided or the manufacturer's instructions have been adhered to.

POWER SOURCES — This product should be operated only from the type of power source indicated on the marking label. If you are not sure of the type of power supply to your home, consult your product dealer or local power company.

LOCATION — The appliance should be installed in a stable location.

NONUSE PERIODS — The power cord of the appliance should be unplugged from the outlet when left unused for a long period of time.

GROUNDING OR POLARIZATION

- If this product is equipped with a polarized alternating current line plug (a plug having one blade wider than the other), it will fit into the outlet only one way. This is a safety feature. If you are unable to insert the plug fully into the outlet, try reversing the plug. If the plug should still fail to fit, contact your electrician to replace your obsolete outlet. Do not defeat the safety purpose of the polarized plug.

- If this product is equipped with a three-wire grounding type plug, a plug having a third (grounding) pin, it will only fit into a grounding type power outlet. This is a safety feature. If you are unable to insert the plug into the outlet, contact your electrician to replace your obsolete outlet. Do not defeat the safety purpose of the grounding type plug.

POWER-CORD PROTECTION - Power-supply cords should be routed so that they are not likely to be walked on or pinched by items placed upon or against them, paying particular attention to cords at plugs, convenience receptacles, and the point where they exit from the product.

OUTDOOR ANTENNA GROUNDING — If an outside antenna or cable system is connected to the product, be sure the antenna or cable system is grounded so as to provide some protection against voltage surges and built-up static charges. Article 810 of the National Electrical Code, ANSI/NFPA 70, provides information with regard to proper grounding of the mast and supporting structure, grounding of the lead-in wire to an antenna discharge unit, size of grounding conductors, location of antenna-discharge unit, connection to grounding electrodes, and requirements for the grounding electrode. See Figure A.

LIGHTNING — For added protection for this product during a lightning storm, or when it is left unattended and unused for long periods of time, unplug it from the wall outlet and disconnect the antenna or cable system. This will prevent damage to the product due to lightning and power-line surges.

POWER LINES — An outside antenna system should not be located in the vicinity of overhead power lines or other electric light or power circuits, or where it can fall into such power lines or circuits. When installing an outside antenna system, extreme care should be taken to keep from touching such power lines or circuits as contact with them might be fatal.

OVERLOADING — Do not overload wall outlets, extension cords, or integral convenience receptacles as this can result in a risk of fire or electric shock.

OBJECT AND LIQUID ENTRY - Never push objects of any kind into this product through openings as they may touch dangerous voltage points or short-out parts that could result in a fire or electric shock. Never spill liquid of any kind on the product.

SERVICING — Do not attempt to service this product yourself as opening or removing covers may expose you to dangerous voltage or other hazards. Refer all servicing to qualified service personnel.

DAMAGE REQUIRING SERVICE - Unplug this product from the wall outlet and refer servicing to qualified service personnel under the following conditions:

- When the power-supply cord or plug is damaged.
- If liquid has been spilled, or objects have fallen into the product.
- If the product has been exposed to rain or water.
- If the product does not operate normally by following the operating instructions. Adjust only those controls that are covered by the operating instructions as an improper adjustment of other controls may result in damage and will often require extensive work by a qualified technician to restore the product to its normal operation.
- If the product has been dropped or damaged in any way.
- When the product exhibits a distinct change in performance — this indicates a need for service.

REPLACEMENT PARTS — When replacement parts are required, be sure the service technician has used replacement parts specified by the manufacturer or have the same characteristics as the original part. Unauthorized substitutions may result in fire, electric shock, or other hazards.

SAFETY CHECK - Upon completion of any service or repairs to this product, ask the service technician to perform safety checks to determine that the product is in proper operating condition.

WALL OR CEILING MOUNTING — The product should not be mounted to a wall or ceiling.

HEAT — The product should be situated away from heat sources such as radiators, heat registers, stoves, or other products (including amplifiers) that produce heat.

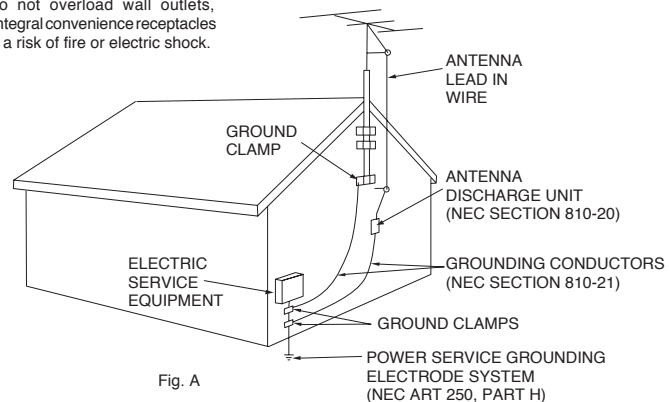

Fig. A

NEC — NATIONAL ELECTRICAL CODE

PRODUCT INFORMATION

1. Heat - The CD player should be situated away from heat sources such as radiators, heat registers, stoves, or other appliances (including amplifiers) that produce heat.
2. Do not let insecticides, benzene, or thinner come in contact with the surface of the unit.
3. Never disassemble or modify your unit in any way, doing so will void your manufacturer's warranty.
4. Never plug this unit into a dimmer pack.
5. Do not attempt to operate this unit if it becomes damaged in any way.
6. This unit is intended for indoor use only, use of this product outdoors voids all warranties.
7. Always mount this unit in a safe and stable manner.
8. Disconnect from main power before making any type of connection.
9. Cleaning -
 - The CD Player should be cleaned only as recommended by the manufacturer. Use a soft cloth to wipe down the outside of the unit. For stubborn stains, moisten a soft cloth with glass cleaner or other mild detergent to wipe away any stains. Use a soft cloth to wipe any residual cleaner. Never use volatile cleaners such as benzene, solvent, or thinner to clean your unit, these cleaners will damage the unit's surface.
 - Cleaning the pick-up lens - The pick-up lens should not become dirty under normal usage. If the lens does become dirty, contact American Audio Technical Support for further instructions. Third party lens cleaners are available but not highly recommended. Use of some of these cleaners may damage the pick-up lens, be sure to follow extreme caution when using these types of cleaners.

This unit has been thoroughly tested and has been shipped in perfect operating condition. Carefully check the shipping carton for damage that may have occurred during shipping. If the carton appears to be damaged, carefully inspect your unit for any damage. Be sure all accessories needed to operate the unit have arrived intact. In the event damage has been found or parts are missing, please contact our toll free customer support number for further instructions. Please do not return the unit to your dealer without first contacting customer support.

LINE VOLTAGE SELECTION

- The desired voltage may be set with the VOLTAGE SELECTOR switch on the rear panel (using a flat head screw driver).
- Do not force the VOLTAGE SELECTOR switch as this may cause damage.
- If the VOLTAGE SELECTOR switch does not move smoothly, please contact a qualified service technician.

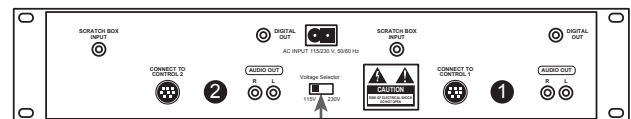

Voltage Line Selector Switch

WARRANTY INFORMATION

The DCD-PRO600™ carries a TWO year (730 days) limited warranty. This warranty covers parts and labor. Please fill out the enclosed warranty card to validate your purchase and warranty. All returned service items, whether under warranty or not, must be freight pre-paid and accompany a return authorization (R.A.) number. If the unit is under warranty, you must provide a copy of your proof of purchase invoice. Please contact American Audio® customer support at (800) 322-6337 for a R.A. number.

CUSTOMER SUPPORT

Customer Support: American Audio® provides a toll free customer support line, to provide set up help and to answer any question should you encounter problems during your set up or initial operation. You may also visit us on the web at www.AmericanAudio.us for any comments or suggestions. For service related issue please contact American Audio®. Service Hours are Monday through Friday 9:00 a.m. to 5:00 p.m. Pacific Standard Time.

Voice: (800) 322-6337
Fax: (323) 582-2941
E-mail: support@AmericanAudio.us

Warning! To prevent or reduce the risk of electrical shock or fire, do not expose this unit to rain or moisture.

Caution! There are no user serviceable parts inside this unit. Do not attempt any repairs yourself, doing so will void your manufactures warranty. In the unlikely event your unit may require service please contact customer support. Please do not return to your dealer without first contacting customer support.

SET-UP

1. Checking the Contents:

Be sure your DCD-PRO600™ was shipped with the following:

- | | |
|-------------------------------------|---|
| 1) DCD-PRO600™ Dual CD player unit. | 1) DCD-PRO600™ Controller Head Unit |
| 2) Dual Male to Male RCA cable. | 2) Q-Start 1/8" Male to Male Mini Plug |
| 1) Warranty card. | 1) Operating instructions (this booklet). |

2. Installing the Units

- 1) Place your unit on a flat surface or mount it in a secure rack mount case.
- 2) Be sure the player is mounted in a well ventilated area where it will not be exposed to direct sunlight, high temperatures, or high humidity.
- 3) Try to place the unit as far as possible from TVs and tuners, as the unit may cause undesirable interference.

3. Connections

- 1) Be sure main power is connected last to prevent any electrical damage.
- 2) **AUDIO CONNECTIONS:** Use the included RCA cable to connect the DCD-PRO600™ outputs to the line inputs of a mixer. Never connect a CD player's output to a mixers "phono" inputs.
- 3) **CONTROL JACK CONNECTIONS:** Use the supplied 1/8" mono mini plug cable to connect your DCD-PRO600™ to a mini jack connection (A or B) on a compatible American Audio® or American DJ® "Fader Q Start" mixer. (This will enable the Fader "Q" Start function - See "Q" start control page 7)

CAUTION: Be sure to use the supplied control cables. Using a different type of cable may result in unit damage. To avoid server unit damage, be sure main power is off when connecting the control cables.

CAUTION:

- The player will work normally when the main unit is mounted with the front panel within 15 degrees of the vertical plane. If the unit is tilted excessively, discs may not be loaded or unloaded properly. (Figure 1)

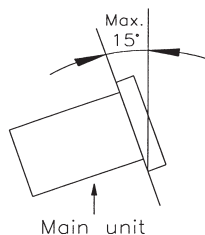

Figure 1

CAUTION:

- The LCD is designed to be clearly visible within the angles shown in Figure 2. Mount the control unit so that the visual angle is within this range.

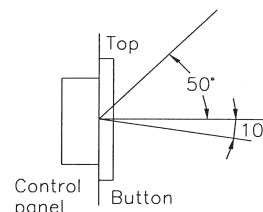

Figure 2

MAIN FEATURES

- 8 times over sampling 1 bit D/A converter
- 20 Seconds Digital Anti-Shock Protection
- 4 Programmable Cue Points or Samples
- Reverse Playback (Unlimited)
- Selectable Time Display
- S/PDIF Digital Audio RCA Coaxial Output
- Fader “Q” Start Control (a)
- Flip-Flop (Relay Playback) (c)
- Sleep Mode (e)
- Selectable Pitch: +/-8%, +/-12% or +/-16%
- Seamless Loop - Uninterrupted Loop Playback
- Large bright LCD Screen can be viewed from wide angles.
- Scratch Box Compatible (h)
- Direct Track Access Buttons
- Instant Start within 10 msec (sound is produced immediately when the PLAY button is pressed)
- Filter Effect
- 2 Coast Effect
- Auto cue Function (Sensitive to -48dB)
- Real-time Cue (“Cue on the Fly”)
- 4 different speed scan
- 30 Programmable Tracks
- Bop Effect (b)
- 60 Second Transport Protection (d)
- Memory Backup, Defaults to last setting (f)
- Jog Wheel Pitch Bend +/-16% (g)
- Pitch Display
- Single/Continuous/Repeat Play Modes
- 1/75 Frame Search
- Tempo Lock
- Tap Sync Beat Counter

(a) **FADER “Q” START CONTROL:** This feature is used in conjunction with American Audio® mixers that also feature “Fader Q Start” control. Connect your DCD-PRO600’s as described in the set-up section of this manual. After set-up is completed, insert CD’s in to both drives. By moving the mixer’s crossfader from left to right you can start and pause your DCD-PRO600 playback functions. For Example, if your mixer’s crossfader is all the way to the left (player one is playing, player two is in cue or pause mode), and you move the fader at least 20% to the right, player two will begin to play and player one will return to cue mode. When the crossfader is to the right, and you move it 20% to the left, player one (will begin to play and player two will return to its’ cue point. You can create great effects similar to scratching with this feature. After storing cue points on each side of the CD player, different songs or samples may quickly be recalled by moving the mixer crossfader back and forth. New cue points can be easily selected on the DCD-PRO600 player (see setting cue points page 13). “Q” Start control is easy to use and mastering this feature will help you create amazing effects with your music. Note for mixers with a Hamster Feature: For proper “Q” Start operation be sure your mixers “Hamster” setting are set to 1/2 (Normal Setting).

(b) **BOP EFFECT:** The Bop Effect button serves two features. First, it is a stutter effect, creating a sound similar to a sampler. Second, it will return to the last Cue point in memory instantly. This will allow you to create great effects. To create the BOP Effect, see BOP Effect on page 22.

(c) **FLIP-FLOP:** This feature is used in conjunction with American Audio® mixers that also feature Fader “Q” Start. For FLIP-FLOP results you must use two DCD-PRO600 players. Connect your DCD-PRO600’s as described in the set-up section of this manual. This feature will start the next player once one player has ended. For example, if player one is playing a disc and it ends, player two will instantly begin to play. You may set FLIP-FLOP to play track to track or disc to disc. For more information on this feature, see FLIP-FLOP™ on page 23.

(d) **60 SECOND TRANSPORT PROTECTION:** The CD transport tray will automatically close if left open for more than 60 seconds. If a CD is left in the tray it will immediately cue.

(e) **SLEEP MODE:** The DCD-PRO600’s laser and pick-up assembly will power down after 15 minutes of inactivity (when in pause or cue mode). This will lengthen the life of your motor drive and laser. To initialize the player, just press the cue or play buttons.

(f) **MEMORY BACKUP:** The DCD-PRO600 has a five year memory back-up, that will save your setting in case the power supply is accidentally disconnected. DCD-PRO600 will automatically remember your last setting (repeat, SGL, CTN) even if you disconnect your main power.. The DCD-PRO600 will store your cue points in memory if you accidentally open transport tray or shut off the power. Note: Memory cues are erased automatically when a new CD is played, or by holding memory button down for 5 seconds.

(g) **JOG WHEEL PITCH BEND:** During normal playback, the inner jog wheel acts as a momentary pitch bend. Turning the wheel in a clockwise direction will increase the speed and turning the wheel in a counter-clockwise direction will decrease the speed.

(h) **SCRATCH BOX COMPATIBLE:** This feature is used in conjunction with the optional American Audio® Scratch Box.™ mixers that also feature “Fader Q Start” control. When the DCD-PRO600 is used in conjunction with the Scratch Box a turntable may be used to control the CD functions. See Optional Scratch Box on page 25.

GENERAL FUNCTIONS AND CONTROLS - REMOTE UNIT

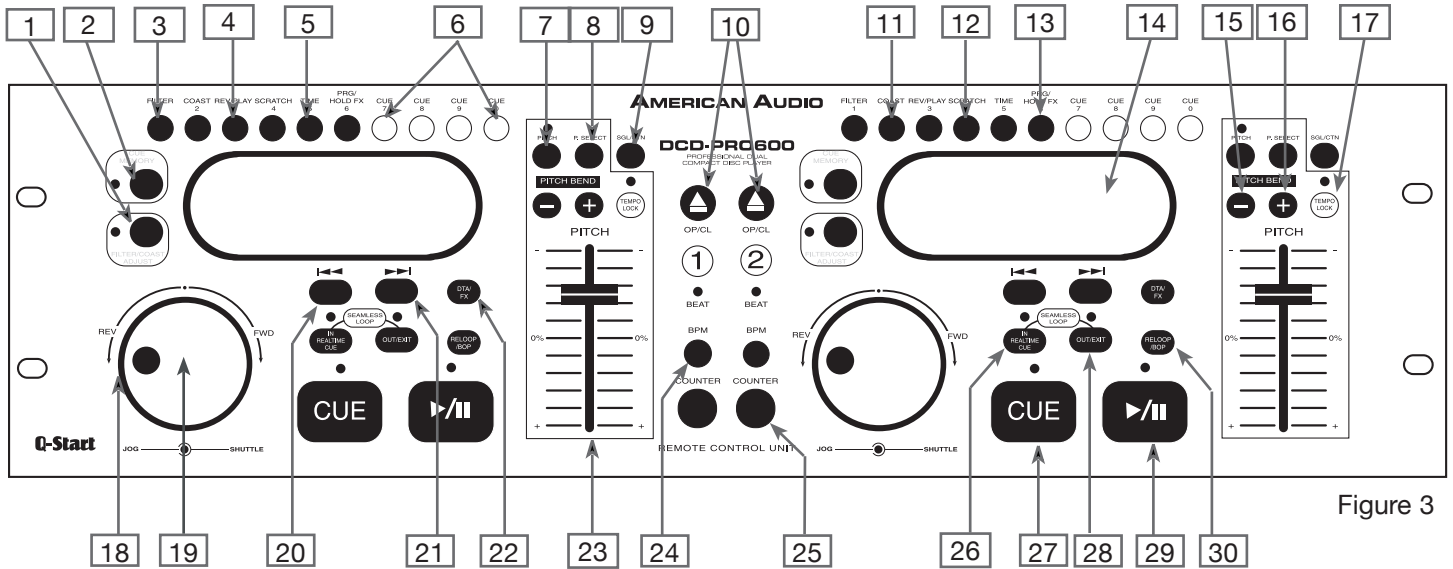

Figure 3

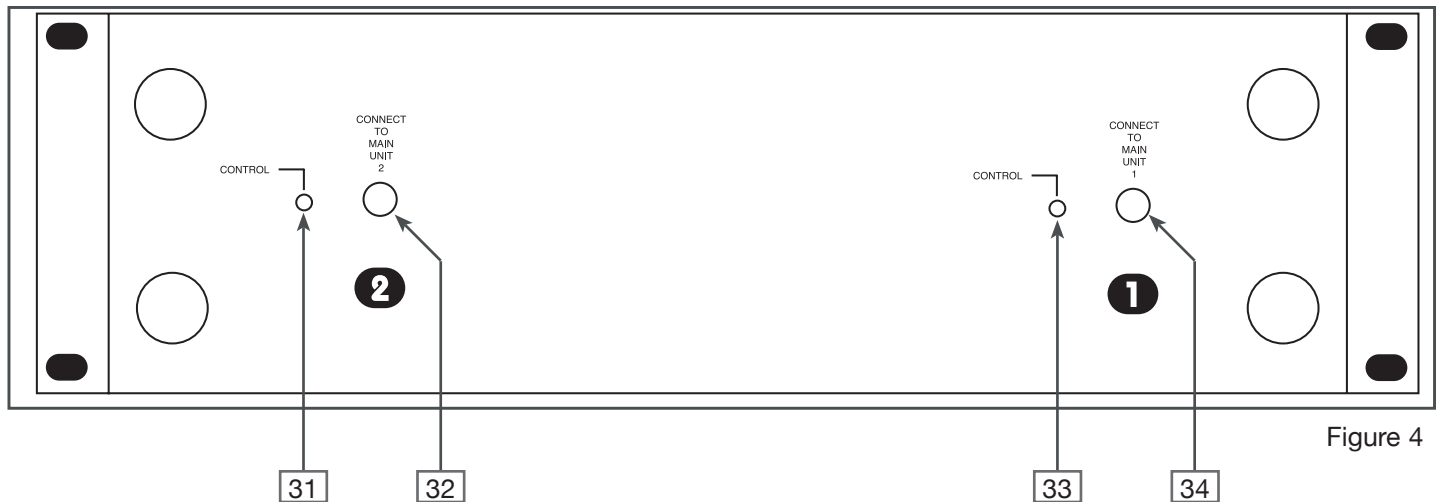

Figure 4

A. REMOTE CONTROL - FACE (FIGURE 3)

- 1. FILTER/COAST/ADJUST** - This button allow you to change the FILTER and Coast values. With the FILTER/COAST/ADJUST button selected (on) the FILTER value is one second and the COAST value is five seconds. With the FILTER/COAST/ADJUST deselected (off) the FILTER value is a 1/2 second and the COAST value is three seconds. A yellow LED will indicated on and off functions.
- 2. CUE MEMORY** - This button allows you to program up to 4 cue points on the CD. For more information on setting a cue point see page 20.
- 3. FILTER** - This button activates the FILTER

effect. This effect simulates the sudden platter stop of a turntable. Almost like pressing the stop button on a turntable. When the FILTER effect is selected a number 1 will appear in the LCD (14), this indicates the FILTER effect is active. See "FILTER" effect on page 27.

- 4. REV/PLAY** - This button activates reverse play mode. When this effect is selected the disc will begin to play in reverse mode, and continue to play in reverse until reverse play function is turned off. If reverse play is not turned off the disc will continue to play in reverse until it returns

GENERAL FUNCTIONS AND CONTROLS - REMOTE UNIT (CONT)

to the beginning of the disc. When the REV/PLAY effect is selected a number 3 will appear in the LCD (14), indicating REV/PLAY is active. See reverse play on page 24.

5. TIME - The TIME button is used to changed the displayed time values. Time can be displayed as elapsed track time, remaining track time, and total disc remaining time.

6. CUE BUTTONS - These button are used to store four user programmable "Cue Points." A "Cue Point" is a starting point anywhere on a disc. To program a "Cue Point" see Cue Points on page 18.

7. PITCH BUTTON - This button is used to turn the pitch function on and off. The pitch functions of the PITCH SLIDER (21), PITCH BEND BUTTONS (25) and JOG WHEEL (19) will not function without this function being activated. The pitch percentage value can be changed from (+/- 8%), (+/- 12%) or (+/- 16%). The PITCH BUTTON's LED will indicate the maximum pitch value by flashing red for 8%, glowing green for 12%, or glowing red for 16%.

8. P. Select (Pitch Select Button) - This button changes the pitch value. The pitch percentage can be changed between 8%, 12%, and 16%. 8% will allow the least amount of pitch manipulation and 16% will allow the most amount of pitch manipulation. To adjust to the different values tap this button. The LED next to the Pitch Button (27) will indicate which pitch percentage mode is activated by, flashing red for 8%, glowing green for 12%, or glowing red for 16%. Note, the Pitch Button (27) must be activated to get a LED reading. The pitch values will immediately reflect the amount of pitch being applied to a music source in the CD drive. The pitch value is adjusted by sliding the PITCH SLIDER (21) up and down.

9. SGL/CTN - This button allows the unit's play mode to change between Single and Continuous. In single mode the unit will play a single track and return to cue mode. In continuous mode the unit continues to play track by track and returns to cue mode after all tracks have played. This

function also operates in PROGRAM and FLIP FLOP modes. In program mode the continuous function will play all tracks in a program, than return to cue mode on the first track in the program. When using two units in Flip-Flop mode, each unit may be set up to run in either single or continuous. In single mode a unit will play a single track and jump to the next unit. If the next unit is in continuous mode, that unit will play all tracks and jump back to next unit, and so on.

10. OPEN/CLOSE (Disc Tray Open/Close)

- This button is used to open and close the disc transport tray door. NOTE: When a disc is loaded, the tray will not open unless the unit is in pause or cue mode.

11. COAST - This button activates the COAST effect. This effect will simulates turning the power off on a turntable, a turntable platter spinning until it slowly loses momentum and stops. When the COAST effect is selected a number 2 will appear in the LCD (14), this will indicates the COAST effect is selected. See Coast effect on page 26.

12. SCRATCH BUTTON - This button is used to activate and deactivate the *Optional* Scratch Box function. For more information on the Scratch Box function see page 24.

13. PRG/HOLD FX - (PROGRAM/FILTER HOLD BUTTON) This button serves two functions. PROGRAM: When used in conjunction with DTA/FX BUTTON (22) this button will activate program mode. When program mode is activated a "PROGRAM" icon will display in the LCD (14). For programming information see "Programming" on page 23. HOLD: This button will also allow you to set and lock any new parameters you set for the FILTER effects. If the hold function is not selected any changes to the FILTER effect parameters will be momentary.

14. LIQUID CRYSTAL DISPLAY (LCD) - This high quality LCD Indicates all the functions (play, pause, cue, etc..), as they occur. This display is viewable at several comfortable angles as described on page 6. The LCD icons will be described in the next section.

GENERAL FUNCTIONS AND CONTROLS - REMOTE UNIT CONT.

15. (-) PITCH BEND - The (-) pitch bend function creates a momentary “Slow Down” in the CD’s pitch speed (Beats per minute - BPM) when the PITCH (7) function is activated. This functions allows the beats between two CD’s or any other music source to match. This is a momentary function. When the button is depressed the pitch speed will automatically return to PITCH SLIDER’S (23) selected pitch. Holding down this button will give a maximum of -16% pitch. Be sure to remember that this function is a momentary pitch adjust-ment, for a more precise adjust-ment use the PITCH SLIDER’S (23) to match the BPM’s with another playing music source.

16. (+) PITCH BEND - The (+) pitch bend function creates a momentary “BUMP” in the CD’s pitch speed (Beats per minute - BPM) when the PITCH (7) function is activated. This functions allows the beats between two CD’s or any other music source to match. This is a momentary function. When the button is depressed the pitch speed will automatically return to PITCH SLIDER’S (23) selected pitch. Holding down this button will give a maximum of +16% pitch. Be sure to remember that this function is a momentary pitch adjust-ment, for a more precise adjustment use the PITCH SLIDER’S (23) to match the BPM’s with another playing music source.

17. TEMPO LOCK - This button will activate the Tempo Lock function. This function will allow you to make adjustment to a track speed using the pitch controls (7, 15, 16, & 23) without altering a tracks perceived tonal pitch.

18. SHUTTLE WHEEL (OUTER RING) - This wheel has two forward and two reverse speed positions for speed searching through tracks. The more you turn the wheel in either direction, the faster you search.

19. JOG WHEEL (INNER WHEEL) - The jog wheel serves two functions depending on the operating mode:

A. The jog wheel will act as a slow frame search control when the unit is in pause or cue mode allowing you to set a specific cue point or

find a particular starting point.

B. The inner wheel also works as a momentary pitch bend during playback. Turning the wheel clockwise will increase the pitch percentage up to 16%, and turning the wheel in the counter-clockwise direction will decrease the pitch percentage up to -16%. The pitch bend will be determined on how fast you turn the wheel.

20. |◀◀ TRACK BUTTON - This buttons is used to select a track. Tapping this button will back-skip to the previous track, holding down this button will rapidly back-skip through the tracks on a CD.

21. ▶▶| TRACK BUTTON - This buttons is used to select your desired track. Tapping this button will forward skip to the next track, holding down this button will rapidly forward skip through the tracks on your CD.

22. DTA/FX (DATA/EFFECTS) - This button serves two functions. This button allows you to change the functions of the effect and cue button along the top of the LCD (14). DATA: The DATA function will be indicated by small arrow icon in the upper left hand corner of the LCD (14). When unit is in DATA mode the effect and cue buttons along the top of the LCD (14) may be used as direct track access buttons. EFFECTS: When the effect function is engaged (no arrow icon in the upper left hand corner of the LCD) the buttons along the top of the LCD (14) will function as they are indicated.

23. PITCH SLIDER - This slider is used to adjust the playback pitch percentage when the PITCH (7) function is activated. The slider is a set adjustment and will remain set until the pitch slider is moved or the PITCH (7) function has been turned off. This adjustment can be made with or without a CD in the drive. The pitch adjustment will remain even if a disc has been remove, and will reflect on any other disc loaded into the unit. That is to say, if you set a +2% pitch on one disc, remove that disc and insert another, that disc too will have a +2% pitch. The amount of pitch being

GENERAL FUNCTIONS AND CONTROLS - REMOTE UNIT (CONT)

applied will be displayed in the LCD (14). Use this slider to match the BPM's of this unit to that of another music source. By changing the pitch of one disc with respect to the other in this way, the beats can be matched.

24. BPM BUTTON - This changes toggles between the PITCH function and BPM function indicators in the LCD. When the BPM function is engaged, the COUNTER (25) button may be used to manually display a tracks BPM's in the LCD (14). When the BPM function is disengage, a tracks pitch value will be displayed in the LCD (14).

25. COUNTER BUTTON - When the unit is BPM mode, tapping this button to tracks beat will determine a tracks BPM's. The BPM value will be displayed in the LCD.

26. IN REAL-TIME CUE (SEAMLESS LOOP IN BUTTON) - "CUE ON THE FLY" - This button allows you to set a CUE POINT (see CUE POINT page 18) without music interruption ("on the fly"). This button also sets the starting point of a loop (see SEAMLESS LOOP on page 21).

27. CUE - Pressing the CUE button during playback immediately pauses playback and returns the track to the last set cue point (see setting a CUE POINT, page 20). The red CUE LED will glow when the unit is in cue mode The LED will also flash every time a new CUE POINT is set. The CUE button can be held down to momentarily play the CD. When you release the CUE button it instantly returns to the last set CUE POINT. You can also tap the CUE button to create a BOP EFFECT (for definition of BOP EFFECT, see page 24).

28. OUT/EXIT - This button serves two functions; 1) This button is used to set the ending point of a loop. 2) During normal loop playback, a loop is exited by pressing the OUT/EXIT BUTTON .

29. PLAY/PAUSE BUTTON - Each press of the PLAY/PAUSE BUTTON causes the operation to change from play to pause or from pause to play. While in play mode the green play LED will glow,

and while in pause mode the green play LED will flash.

30. RELOOP/BOP BUTTON - This button controls two functions;

- A. RELOOP; If a Loop has been made (see setting a Seamless Loop on page 21), but the unit is not actively in Loop mode (a loop is not playing), pressing the RELOOP/BOP BUTTON will instantly reactivate Loop mode. To exit the Loop , press the OUT/EXIT BUTTON (28). LOOP (65) and RELOOP (64) will display in the LCD (14) when the Reloop function is available.
- B. BOP; This button is used to activate the BOP Effect. A Bop Effect is a stutter, creating a sound similar to a CD skipping. This function will instantly play the last set cue point during playback without music interruption. The Bop Effect can be created in 2 ways. See creating a BOP on page 24.

B. REMOTE CONTROL - REAR (FIGURE 4)

31. CHANNEL 2 CONTROLLER JACK - Connect the supplied mini-plug from the CUE jack on the rear of your CD unit to the CONTROL out jack of a compatible American Audio® or American DJ® mixer. This will enable the CD "Q-Start" function. This feature is only available on American Audio® or American DJ® "Q" series mixers.

32. CHANNEL 2 REMOTE JACK - Connect the supplied 8 pin din cable from this jack to the player's channel 2 remote connector. This will allow you to control the player functions.

33. CHANNEL 1 CONTROLLER JACK - Connect the supplied mini-plug from the CUE jack on the rear of your CD unit to the CONTROL out jack of a compatible American Audio® or American DJ® mixer. This will enable the CD "Q-Start" function. This feature is only available on American Audio® or American DJ® "Q" series mixers.

34. CHANNEL 2 REMOTE JACK - Connect the supplied 8 pin din cable from this jack to the player's channel 1 remote connector. This will allow you to control player 1's functions.

GENERAL FUNCTIONS AND CONTROLS - PLAYER UNIT

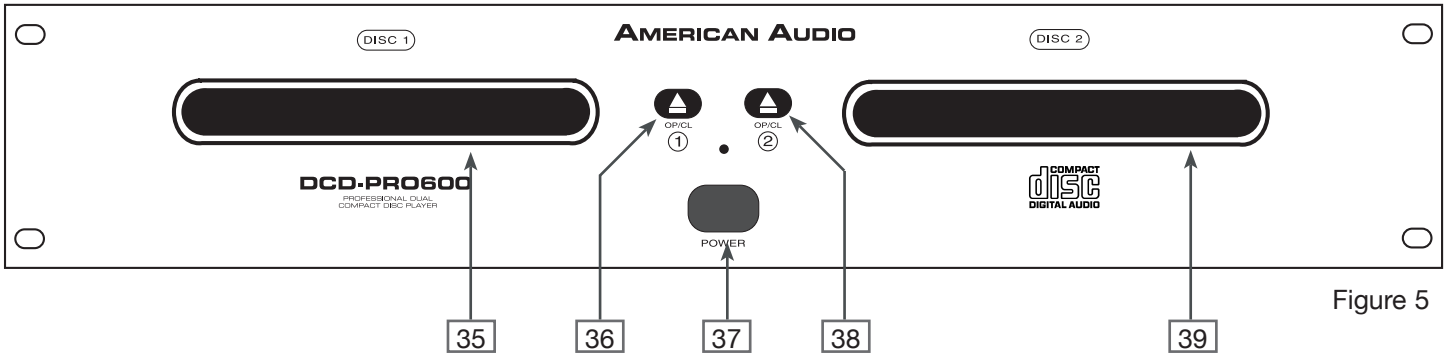

Figure 5

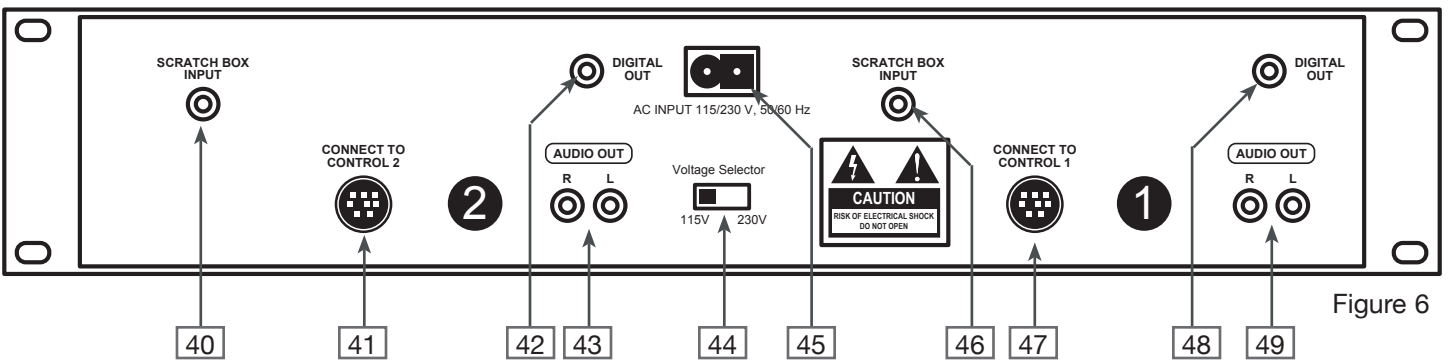

Figure 6

C. TRANSPORT UNIT - FACE (FIGURES 5)

35. DRIVE 1 TRANSPORT TRAY - This tray is used to load and load compact disc in to the drive 1 mechanism. The tray is opened and closed by pressing the DRIVE 1 OPEN/CLOSE BUTTON (36). Never attempt to force the transport tray open or closed when the power is turned off.

36. DRIVE 1 OPEN/CLOSE (Transport Tray Open/Close) - This button is used to open and close the drive 1 transport tray. NOTE: When a disc is already loaded in the transport tray, the tray will not open unless the unit is in pause or cue mode.

37. POWER SWITCH - This switch is used to control the unit's main power. A blue LED directly above the power switch will glow to indicate main power is active.

38. DRIVE 2 OPEN/CLOSE (Transport Tray

Open/Close) - This button is used to open and close the drive 2 transport tray. NOTE: When a disc is already loaded in the transport tray, the tray will not open unless the unit is in pause or cue mode.

39. DRIVE 2 TRANSPORT TRAY - This tray is used to load and load compact disc in to the drive 2 mechanism. The tray is opened and closed by pressing the DRIVE 2 OPEN/CLOSE BUTTON (38). Never attempt to force the transport tray open or closed when the power is turned off.

D. TRANSPORT UNIT - REAR (FIGURES 6)

40. OPTIONAL SCRATCH BOX INPUT (Drive 2) - This jack is used to receive the digital Scratch Box signal. Use the included stereo mini plugs to connect the Scratch Box to the to this jack. Be sure to use a dual stereo jack for proper function-

GENERAL FUNCTIONS AND CONTROLS - PLAYER UNIT

ality. For more information on the Scratch Box refer to the Scratch Box manual.

41. DRIVE 2 REMOTE JACK - Connect the supplied 8 pin din cable from this jack to the remote control's channel 2 remote connector. This will allow you to control the player functions with the remote unit.

42. DRIVE 2 DIGITAL OUT - This jack sends a digital stereo out signal. Use this connection to create near perfect copies of your disc to a Mini disc, CD-R, or any other recording device with a digital input.

43. DRIVE 2 AUDIO OUT R & L - These jacks send a left and right analog mono output signal. Use these jacks to send standard audio to a mixer or receiver. The red colored jack represents the right channel output and white jack represents the left channels output.

44. VOLTAGE SELECTOR - Because power supplies vary from location to location a voltage selector switch has been incorporated in the unit's design. This switch can select a voltage input of 120v or 220v to accommodate the two major power source. Always be sure to disconnect the power plug before changing the voltage.

45. POWER CONNECTOR - This is the main

power connection. Only use the supplied polarized power cord. Use of any other power may result in sever damage to the unit. Be sure the local power matches the unit's required power.

46. OPTIONAL SCRATCH BOX INPUT (Drive 1)- This jack is used to receive the digital Scratch Box signal. Use the included stereo mini plugs to connect the Scratch Box to the to this jack. Be sure to use a dual stereo jack for proper functionality. For more information on the Scratch Box refer to the Scratch Box manual.

47. DRIVE 1 REMOTE JACK - Connect the supplied 8 pin din cable from this jack to the remote control's channel 1 remote connector. This will allow you to control the player functions with the remote unit.

48. DRIVE 1 DIGITAL OUT - This jack sends a digital stereo out signal. Use this connection to create near perfect copies of your disc to a Mini disc, CD-R, or any other recording device with a digital input.

49. DRIVE 1 AUDIO OUT R & L - These jacks send a left and right analog mono output signal. Use these jacks to send standard audio to a mixer or receiver. The red colored jack represents the right channel output and white jack represents the left channels output.

LIQUID CRYSTAL DISPLAY (LCD)

LCD DISPLAY

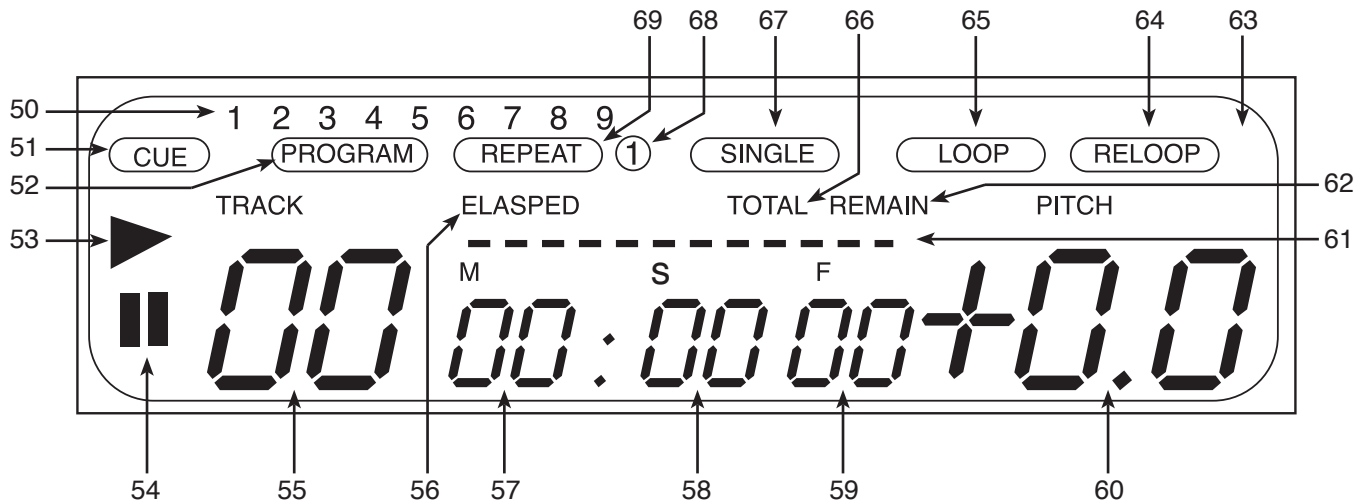

Figure 7

E. LCD DISPLAY (FIGURE 7)

50. FUNCTION INDICATORS - These indicators serve two functions; Indicators 1-3 detail which effect is active, Indicators 6-9 detail a cue point stored in memory.

51. CUE INDICATOR - This indicator will glow when the unit is in CUE mode and will flash every time a new CUE POINT is recorded in memory (see setting CUE POINTS on page 20).

52. PROGRAM INDICATOR - This icon indicates "Program Mode" is activated. See Program Play on page 23 for more information on programming.

53. PLAY INDICATOR - This indicator will glow when the unit is in play mode.

54. PAUSE INDICATOR - This indicator will glow when the unit is in pause or cue mode.

55. TRACK INDICATOR - This double digit indicator details a current track. The number displayed in the track indicator is a direct reference to a track being selected for programming or a track in play, pause, or cue mode.

56. ELAPSE INDICATOR - This indicator is in direct reference to the TIME METER (57, 58, &

59) When the ELAPSE indicator is displayed in the LCD (14), the time defined will refer to a single track's elapsed time. The time mode is changed by the tapping on the TIME BUTTON (5).

57. MINUTES METER - This meter will display the elapse, total, or remaining time in minutes. The display time will be indirect reference to the current time mode.

58. SECONDS METER - This meter will display the elapse, total, or remaining time in seconds. The display time will be indirect reference to the current time mode.

59. FRAME METER - This meter will display the elapse, total, or frames. The displayed frames will be indirect reference to the current time mode.

60. PITCH METER - This meter displays the pitch percentage being applied to playback by the PITCH SLIDER (23). If the meter read zero regardless of the PITCH SLIDER'S (23) position, the PITCH (7) function is not activated.

61. TIME BAR INDICATOR - This bar visually details the time defined in the TIME METER (57,

LIQUID CRYSTAL DISPLAY (CONT)

58, & 59). As with the TIME METER (57, 58, & 59), this bar is also dependent on the selected time function TOTAL REMAIN (66), REMAIN (62) OR ELAPSE (56). This bar will begin to flash when 15 seconds of a track remain and will begin to rapidly flash when three seconds of a track remain. The flashing bar is a great visual reminder a track is about to end. The flashing bar will function regardless of which time mode the unit is in.

62. REMAIN INDICATOR - This indicator is in direct reference to the TIME METER (57, 58, & 59). When the REMAIN indicator is displayed in the LCD (14), the time defined will refer to a single track's remaining time. The time mode is changed by tapping on TIME BUTTON (5).

63. DATA/FX INDICATOR - This icon will display when the DATA function is engaged. When the DATA function is engaged the buttons along the top of the LCD (14) will function as they are detailed. When this icon is off the buttons along the top of the LCD (14) will function as direct track access buttons.

64. RELOOP INDICATOR - This icon will display when a LOOP is engaged or is set and ready to be engaged.

65. LOOP - This icon flashes when a loop is engaged or displays when a loop is not engaged but is set and ready to be engaged.

66. TOTAL REMAIN INDICATOR - This indicator is in direct reference to the TIME METER (57, 58,

& 59). When the TOTAL REMAIN indicator is displayed in the LCD (14), the time defined will refer to a disc's total remaining time. The time mode is changed by tapping on TIME BUTTON (5).

67. SINGLE INDICATOR - This indicates the unit is in single play mode, the unit will play a single and return to CUE mode. If the single indicator is not displayed the unit is in continuous mode. In continuous mode the drive will play through all the tracks on the disc. Once all the tracks have ended the unit will return to cue mode.

68. ① INDICATOR - This indicator is in direct reference to the REPEAT (69) indicator and repeat program play function (see programming on page 23). When the repeat function is first activated, the unit enters a repeat track mode. This mode will repeat a single track over and over until the repeat function is disengaged. The single track repeat function is indicated by the REPEAT (69) and ① icons in the LCD (14).

69. REPEAT INDICATOR - This indicator is in direct reference to the repeat program play function (see programming on page 23). When the repeat function is activated the "REPEAT" (69) icon will display in the LCD (14). When the repeat function is first activated, the unit enters a repeat track mode. This function is indicated by the REPEAT (69) and ①(68) icons in the LCD (14).

BASIC OPERATIONS

1. OPENING AND CLOSING THE DISC TRAY/LOADING DISCS

This is an electronic operation and can only work when the power is on. Press the OPEN/CLOSE BUTTON (10) to open or close the disc tray. Pressing the PLAY/PAUSE BUTTON (29), will also automatically close the tray if it is open and immediately cue any CD that is in it. If the transport tray is left open for more than 60 seconds it will close automatically to prevent accidental damage to the transport. Again if a CD is left in the transport tray it will immediately cue to the first song. The disc trays cannot be opened during playback to prevent playback from being interrupted if the OPEN/CLOSE BUTTON (10) is pressed accidentally. Stop playback, then press the OPEN/CLOSE BUTTON (10).

2. LOADING DISCS

The DCD-PRO600 can play both 3 inch (8 cm) and 5 inch (12 cm) compact discs (CD's). Odd shaped and oval CD's are not compatible. When loading a CD into the unit always hold the disc by its' edges and place it in the disc tray. Never touch the signal surface (the glossy side). When using 5 inch/12 cm discs, place the disc in the outer tray guides (figure 7), and when using 3 inch/8 cm discs, place them securely in the inner guides (figure 8).

CAUTION:

- NEVER insert any foreign objects in the disc tray.
- NEVER attempt to insert more than one disc in the disc tray at a time. Doing so may result in severe damage to the unit.
- NEVER force the transport tray open or closed when the power is off, as this may result in malfunction and damage the transport system.

3. SELECTING TRACKS

Select a desired track by using either of the two TRACK BUTTONS (20 & 21). Tapping the TRACK BUTTONS (20 & 21) once will select either a higher or lower track. You may hold down the TRACK BUTTONS (20 & 21) to change tracks continuously at a higher speed. If you are using the TRACK BUTTONS (20 & 21) to select a new track during playback (a track already playing) the new track you selected will immediately begin playback as soon as the search operation is completed.

4. STARTING PLAYBACK

Insert an audio CD as describe above (loading discs). Pressing the PLAY/PAUSE BUTTON (29) with an audio CD inserted will immediately start playback. The PLAY INDICATOR (53) will glow as soon as playback begins. The point at which playback starts (cue point) will automatically be stored in the memory as the cue point. The unit will return to this cue point (the point at which playback started) when the CUE BUTTON (27) is pressed.

5. STOPPING PLAYBACK

Stopping playback will not stop the drive mechanism, but merely pause or cue the track. There are two ways to stop playback:

- 1) Press the PLAY/PAUSE BUTTON (29) during playback to pause at that point.
- 2) Press the CUE BUTTON (27) during playback to return the track to it's last cue point.

6. PAUSING

Pausing temporarily stops playback. Pressing the PLAY/PAUSE BUTTON (29) changes the operating mode between play and pause. The PAUSE INDICATOR (54) in the LCD (14) will glow when pause mode is activated or when a track is in cue mode.

7. AUTO CUE

"Cueing" is the action of preparing for playback. When the unit is in cue mode the CUE INDICATOR (51) in the LCD (14) will glow. The unit is designed to automatically cue at the first audible signal on the first of a disc when a disc is inserted. If a track is selected before a disc is inserted, the unit will automatically cue to the first audible signal for the selected track.

5 in. / 12cm disc

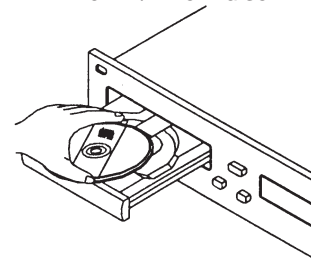

Figure 7

3 in. / 8cm disc

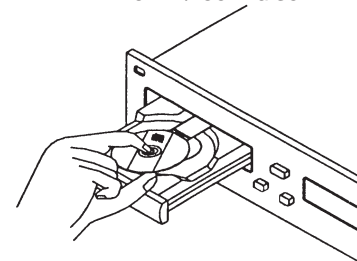

Figure 8

BASIC OPERATIONS (CONT)

8. FRAME SEARCH

This feature allows you to scroll through a track to set a cue, starting sample, or loop point. To use the scroll function you must first be in Pause Mode or Cue Mode. Once you are in Pause or Cue mode, use your finger tip to turn the JOG WHEEL (19) to scroll through the track (figure 9). Turning the wheel in a clockwise direction will advance the frame search and turning the wheel in a counter-clockwise direction rewinds the frame search. When you use the JOG WHEEL (19) the monitor (headphone level) function allows you to hear what you are scrolling through. Once you reach your desired starting point you can set a cue (starting) point by pressing the PLAY/PAUSE BUTTON (29) as in figure 9. Pressing the CUE BUTTON (27) will return the disc to the cue point just set.

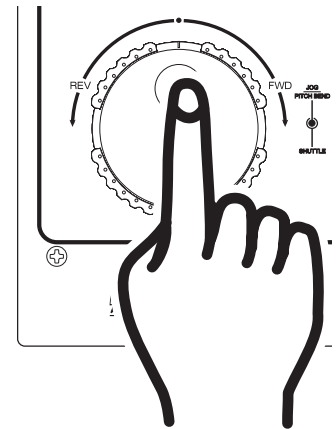

Figure 9

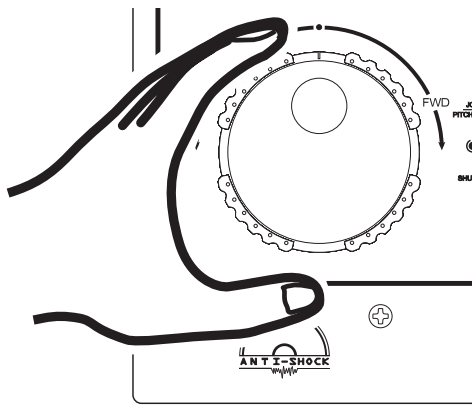

Figure 10

9. SCANNING (FAST FORWARD / FAST REVERSE)

This function gives you a fast search through a disk or track. To do this turn SHUTTLE WHEEL (18) in clockwise direction for fast forward or counterclockwise for fast reverse. You can scan in 6 different forward and 6 different reverse speeds depending on how much you rotate the wheel.

10. CHANGING THE TIME DISPLAY (42, 43, & 44)/TIME BAR (46):

The time may be displayed in three different modes; Elapsed, Remain, and Total Remain. During normal playback, pressing the TIME BUTTON (5) as in figure 11, will change the time display information (57, 58, & 59) in the LCD (14). The following is a break down of the time settings and their definitions:

- 1) ELAPSED (56) - This details the time in the LCD (14) as the current tracks' elapsed running time. The elapsed function only details a tracks elapsed time and not the entire disc.
- 2) REMAIN (62) - This details the time in the LCD (57, 58, & 59) as the current tracks' remaining running time.
- 3) TOTAL REMAIN (66) - This details the time in the LCD (14) as the total disc remaining time.

TIME BAR INDICATOR - The time bar in the LCD (14) visually details the time defined in the TIME METER (57, 58, & 59). This bar is also dependent on the selected time function TOTAL REMAIN (66), REMAIN (62) or ELAPSE (56). This bar will begin to flash when 15 seconds of a track remain and will begin to rapidly flash when three seconds of a track remain. The flashing bar is a great visual reminder a track is about to end. The flashing bar will function regardless of which time mode the unit is in.

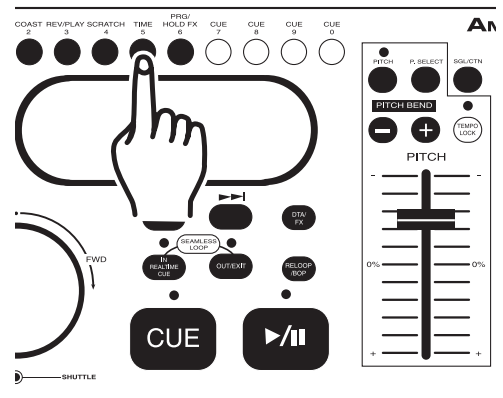

Figure 11

BASIC OPERATIONS (CONT)

11. PITCH ADJUSTMENTS:

This function will increase or decrease a tracks playback speed or "PITCH," this is not a momentary change as in "PITCH BENDING" (see page 19). The maximum pitch bend percentage allowed is +/-16%. The PITCH SLIDER (21) is used to decrease or increase the playback pitch. If the slider is move up (towards the top of the unit) the pitch will decrease, if the slider is moved down (towards the bottom of the unit) the pitch will increase. The PITCH SLIDER (23) adjustment can be changed to range from +/-8%, +/-12%, or +/-16% (See changing "PITCH SLIDER PERCENTAGE RANGE" figure 19/page 20). The pitch adjustments will effect playback, reverse playback, and loops.

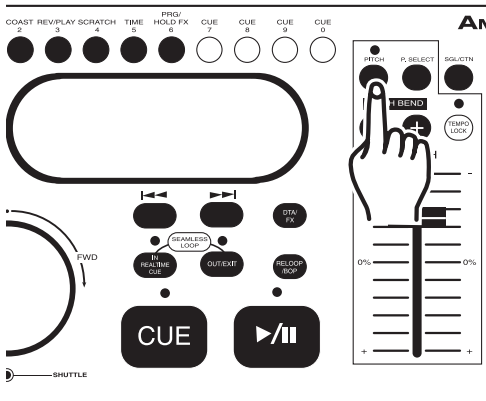

Figure 12

Using the Pitch Slider (21): To use the PITCH SLIDER (23) slide the slider up and down. Down will increase the pitch and up will decrease the pitch. When the slider is in the center position, a green LED just left of the slider will glow. When this slider LED is glowing there is zero pitch being applied to a track.

Activating the Pitch Slider (23): To activate the PITCH SLIDER (23), turn the pitch function on. Press the PITCH BUTTON (7) to turn on the pitch function, when the pitch function is activated a LED will begin to glow (or flash depending on what pitch percentage value is selected, see changing pitch values on page 18). If the pitch function is not activated neither the PITCH SLIDER (23) nor the PITCH BEND BUTTONS (15 & 16) will not function.

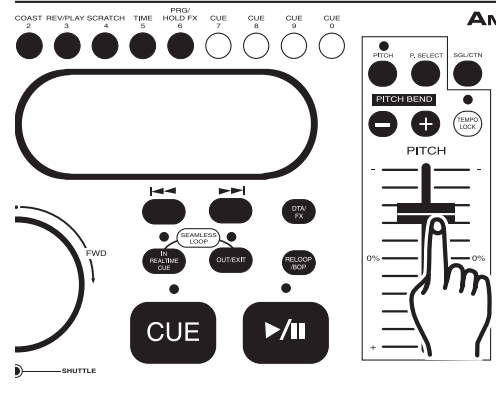

Figure 13

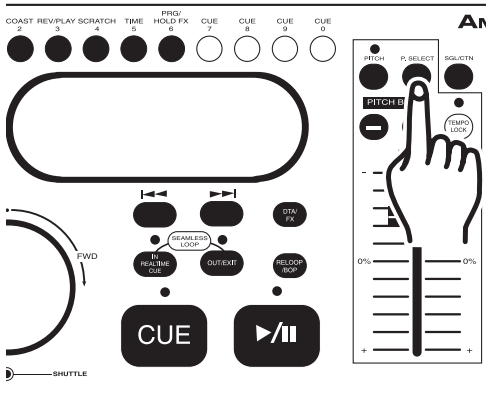

Figure 14

Adjusting the Pitch Slider's Range (21): You may change the PITCH SLIDER'S (23) operating range. To change the operating range be sure the pitch function is turned on, see figure 17. The pitch percentage can be changed between +/-8%, +/-12%, and +/-16%. +/-8% will allow the least amount of pitch manipulation and +/-16% will allow the most amount of pitch manipulation. To adjust to the different values tap the P.SELECT BUTTON (8). The LED beside the PITCH BUTTON (7) will indicate which pitch percentage mode the unit is operating in. Glowing green for +/-8%, glowing orange for +/-12%, or glowing red for +/-16%. Note, the pitch function must be activated to receive a LED reading.

BASIC OPERATIONS (CONT)

12. PITCH BEND:

This function will momentarily increase or decrease a tracks playback speed. There are two ways to operate this function with the (-) & (+) PITCH BUTTONS (25) or with the JOG WHEEL (19). The maximum pitch bend percentage allowed is +/- 16%. The pitch bend function will work in conjunction with the PITCH SLIDER (23) pitch setting. The PITCH SLIDER (23) adjustment can be changed to range from +/-8%, +/-12%, or +/-16% (See changing "PITCH SLIDER PERCENTAGE RANGE" on page 16). For example, if the PITCH SLIDER (23) is set to a 2% pitch gain the pitch bending process will begin at 2% and will continue to the maximum of -/+16%.

PITCH BEND BUTTONS (15 & 16):

The (+) PITCH BEND BUTTON (15 & 16) will provide a speed bump and the (-) PITCH BEND BUTTON (15) will provide a slow down. The extent to which the speed changes is proportionate to the amount of time the button is pressed. For example, if the (+) PITCH BEND BUTTON (16) is held down continuously, the disc speed will increase and will continue to increase until reaches a maximum of 100% speed gain. When you release the (+) PITCH BEND BUTTON (16) the disc speed will automatically return to it's previous speed.

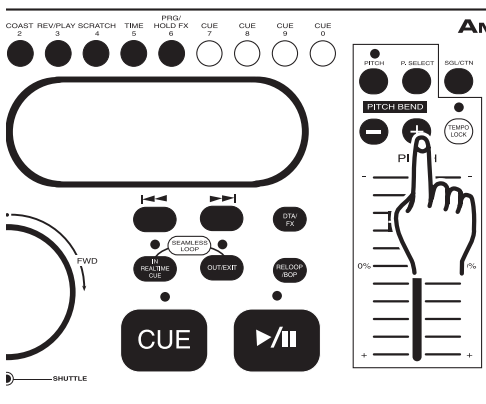

Figure 15

Holding down or tapping on the (+) PITCH BEND BUTTON (16) will provide a speed bump in the playback pitch.

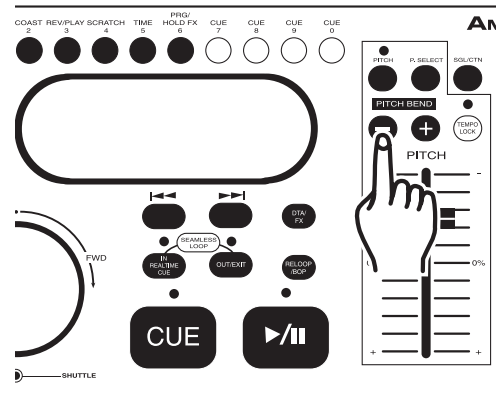

Figure 16

Holding down or tapping on the (-) PITCH BEND BUTTON (15) will provide a slow down in the playback pitch.

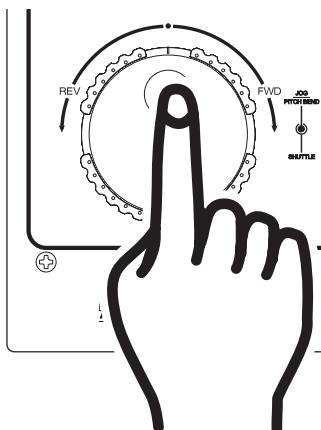

Figure 17

JOG WHEEL (19):

The JOG WHEEL (19) will temporarily bend the pitch if a track is in play mode. Rotating the wheel in a clockwise direction will increase your track pitch and rotating the wheel in a counter-clockwise direction will slow your track pitch. The speed you rotate the JOG WHEEL (19) will determine pitch bend percentage (%).

BASIC OPERATIONS (CONT)

13. SETTING and STORING a CUE POINT:

Setting A Cue Point:

A cue point is the exact point playback will begin when the PLAY/PAUSE BUTTON (29) is pressed. A cue point may be anywhere on a disc or in a track. You may set and store up to five independent cue points per disc. Four cue points are stored in the CUE MEMORY BUTTONS (6) and one in the IN REAL-TIME CUE BUTTON (26). Once a cue point is set it may be recalled at any time during normal playback. Figures 18 and 19 will detail the procedures for setting your custom cue points. There are two ways to set a CUE point:

- 1) Press the IN REAL-TIME CUE BUTTON (26) on the fly (while a disc is playing). This will set a CUE Point without music interruption. Once this point is set, you may return to this point at any time by pressing either the CUE BUTTON (27) or the RELOOP/BOP BUTTON (30). Pressing the CUE BUTTON (27) will stop playback and return the disc in cue mode, pressing the RELOOP/BOP BUTTON (30) will return the disc to cue point without music interruption and continue playback from that point.

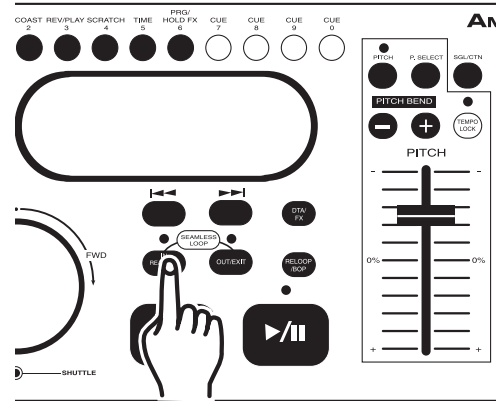

Figure 18

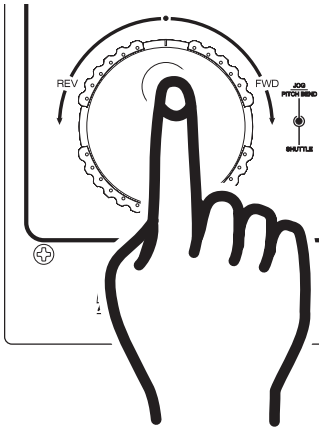

Figure 19

- 2) The JOG WHEEL (19) may be used to set a cue point by frame. While a disc is in pause or cue mode, use the JOG WHEEL (19) to scroll through a track to find your desired starting point. Once you have found your desired cue point press the PLAY BUTTON (29) to enter this point in to the unit's memory. At this point pressing either the CUE BUTTON (27) or the RELOOP/BOP BUTTON (30) will return you to this exact point.

Storing A Cue Point: Once you have set a cue point by one of the two means as detailed above, you may store this point in any one of the CUE MEMORY BUTTONS (6). Once a cue point is stored in to memory it may be recalled at any time by pressing the cue button it was stored into. A cue point may even be recall if the disc has been remove or power had been disconnected. To Store a cue point:

- 1) Create a cue point, press the CUE MEMORY BUTTON (6), as in Figure 20. The yellow Cue Memory LED will glow. This indicates a cue point is ready to be stored in to memory.

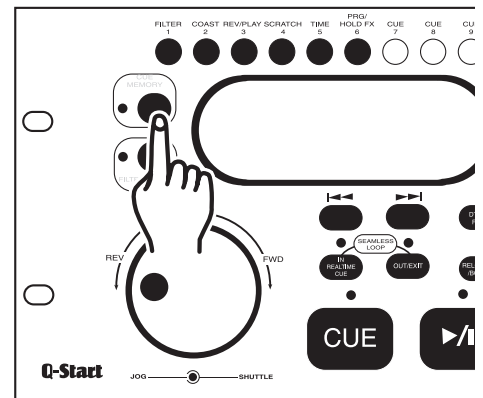

Figure 20

BASIC OPERATIONS (CONT)

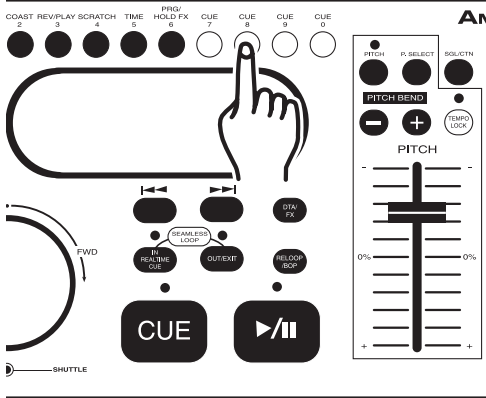

Figure 21

- 2) At this point pressing any one of the four CUE BUTTONS (6) will store your cue point into memory (Figure 21), and the yellow Cue Memory LED will shut off.
- 3) Repeat steps one and two to store up to four Cue Points. Once all your four cue points have been stored you may access them at any time.
- 4) During playback the cue points will instantly start without any music interruption. During play or pause mode accessing a stored cue point will cue to that point in pause mode.

14. CREATING AND PLAYING A SEAMLESS LOOP

A seamless loop is a sound loop that plays continuously without sound interruption. You can use this loop to create dramatic effect in your mixing. This loop has no time limit and you could actually loop the entire length of disc. You create a seamless loop between two continuous points of a disc. The following steps illustrate the procedures for creating a seamless loop:

- 1) Press the PLAY/PAUSE BUTTON (29) to activate playback mode.

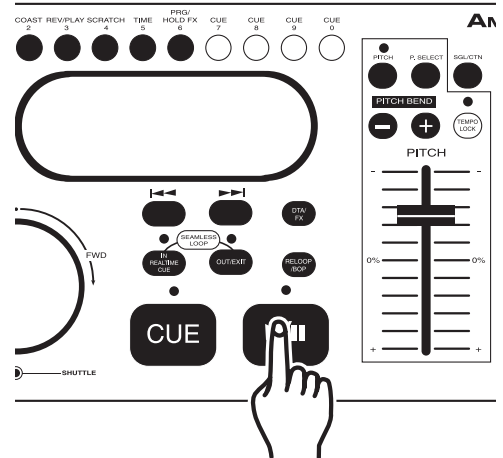

Figure 22

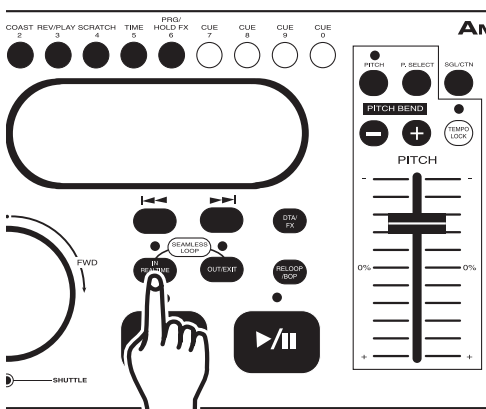

Figure 23

- 2) Press the IN REAL-TIME CUE BUTTON (26). This will set a loops starting point. The IN REAL-TIME CUE BUTTON LED will briefly indicating a starting point has been set.

BASIC OPERATIONS (CONT)

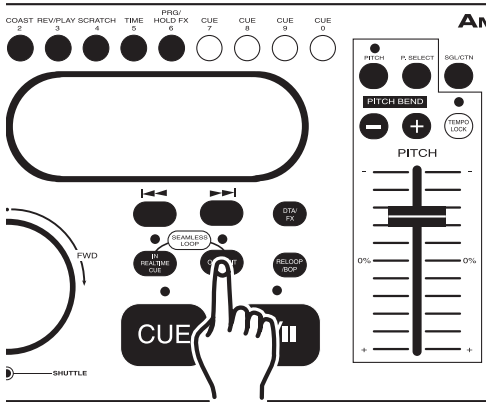

Figure 24

EXITING A LOOP - To exit a SEAMLESS LOOP, press the OUT/EXIT BUTTON (28). The IN REAL-TIME CUE BUTTON (26) and OUT/EXIT BUTTON (28) LEDs will remain on, but will stop flashing. Music playback will resume normal play (Figure 25). The IN REAL-TIME CUE BUTTON (26) and OUT/EXIT BUTTON (28) LEDs will remain on to remind you that a loop is stored in memory.

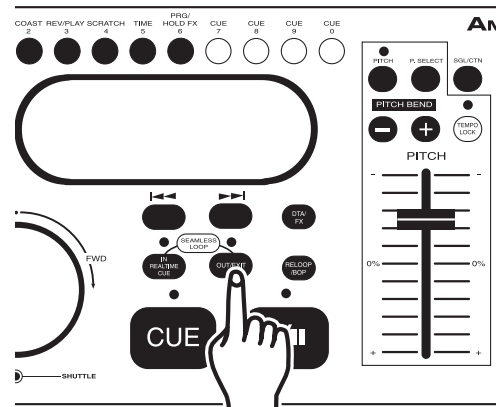

Figure 25

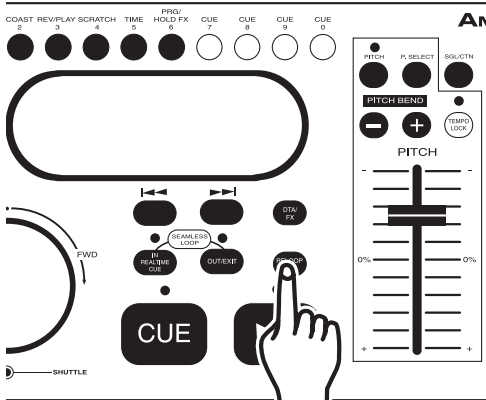

Figure 26

15. EDITING A LOOP:

Please note only the ending point of a loop may be edited, a loop may be made shorter or longer. Before you can edit your seamless loop you obviously must first have created a seamless loop to edit. If you haven't created a SEAMLESS LOOP, follow the instructions in step 10. If a SEAMLESS LOOP has already been created, press the RELOOP/BOP BUTTON (30) to activate your SEAMLESS LOOP (Figure 26), if it is not already playing. To edit a loop's ending point:

- 1) Press the OUT/EXIT BUTTON (28) to return to normal play from the loops cue point (Figure 25). This will disengage the SEAMLESS LOOP and allows you to edit the loops ending point.
- 2) Press the OUT/EXIT BUTTON (28) again when you reach your new ending point (Figure 25).
 - FOR A SHORTER LOOP: Press the OUT/EXIT BUTTON (28) at sooner point in the track (Figure 25).
 - FOR LONGER LOOP: Press the OUT/EXIT BUTTON (28) at later point in the track (Figure 25).

BASIC OPERATIONS (CONT)

16. PROGRAM PLAY

This operation allows you to customize your disc playback. You may select specific tracks to played and the order they will be played in. You may program a maximum of 30 tracks at once and program a single track to played more than once. To create a program:

- 1) Be sure a disc is inserted in the drive and press the DTA/FX(22) and PRG/HOLD FX (13) at the same time. Pressing the DTA/FX(22) and PRG/HOLD FX (13) from any function will immediately pause the disc and enter the program mode.
- 2) After activating the program mode the PROGRAM INDICATOR LED(52) in the LCD (14) will begin to glow indicating Program Mode has been activated.

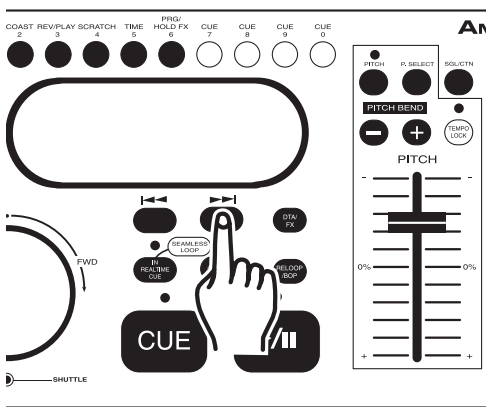

Figure 27

- 3) Select a track to be programmed by using the FORWARD TRACK SKIP (21) and BACK SKIP TRACK BUTTON (20).

- 4) Once you reach the track you wish to place in to the program memory pressing PRG/HOLD FX (13) will lock the track into memory.

Figure 29

- 5) Repeat these steps three and four up to 29 times (up to 30 tracks may be programmed).
- 6) As you program tracks into memory, the LCD (14) will indicate how many tracks have been programmed.

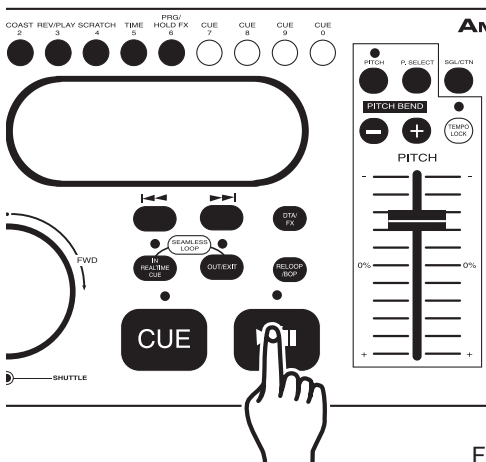
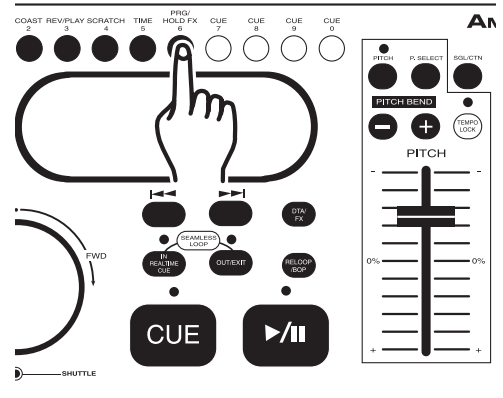
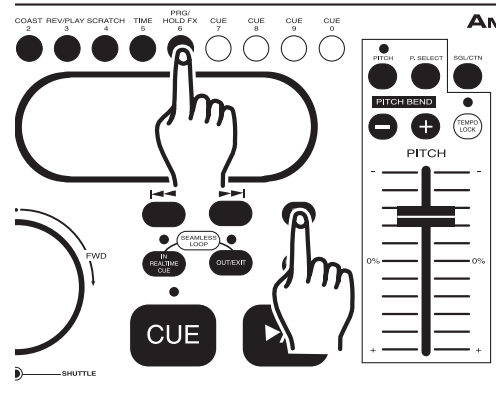

Figure 30

- 7) When you have finished your programming and are ready to begin playback simply press the PLAY/PAUSE BUTTON (29) and your program will begin to play.
- 8) After you have complete your program you can always add more tracks to your program by repeating the steps one through four. Remember that you can only a maximum of 30 track in a program and you can only add track not subtract.
- 9) To cancel and clear the program press and hold down the DTA/ FX(22) and PRG/HOLD FX (13) for more than two seconds (see figure 27).



ADVANCED OPERATIONS

Creating a BOP Effect:

The Bop Effect is a stutter effect that is similar to a CD skipping. You can use this effect to create tricks in your mixing. Creating a BOP effect is a simple process:

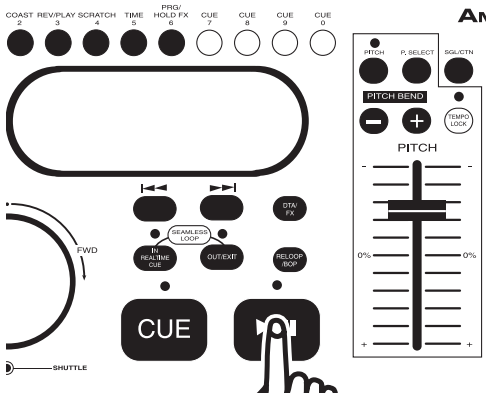

- 1) Press the PLAY/PAUSE BUTTON (29) so music is playing (Figure 31).

Figure 31

- 2) Press the IN REAL-TIME CUE BUTTON (26) at the point you want your BOP to take place (Figure 32).

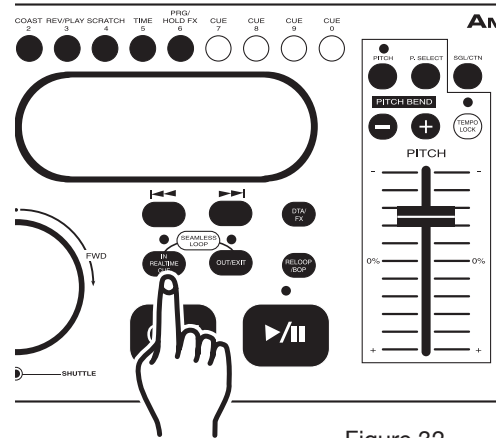

Figure 32

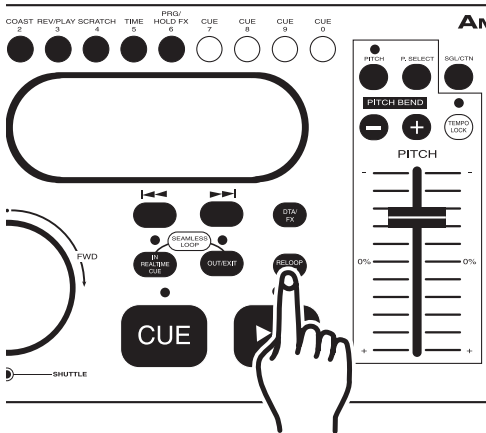

Figure 33

- 3) Now tap the RELOOP/BOP BUTTON (30). It will produce a stutter effect as quickly as you tap on the RELOOP/BOP BUTTON (30). See Figure 33.

Reverse Play:

Reverse play allows you to play a track, loop, or sample backwards. This function is activated by pressing the REV/PLAY BUTTON (4) as in figure 34. This function will react differently to different playback modes:

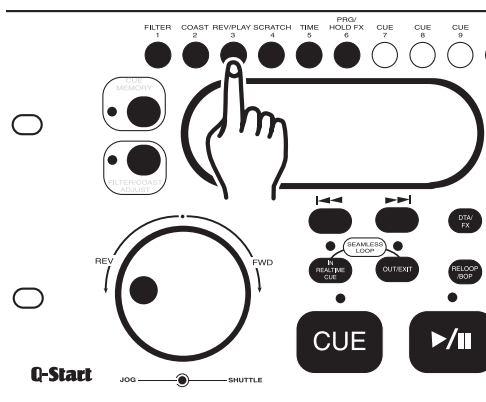

Figure 34

- Reverse track/disc play. In this mode the unit will playback in reverse until the reverse function is turned off. If the reverse function is not turned off the unit will continue to play the remainder of the disc in reverse mode until it reach the begging of the disc. When the unit comes to the beginning it will automatically cue to the first track. If the unit is paused in this mode it will continue to play in reverse when playback begins again.
- Reverse loop play. In this mode the loop will play in reverse once and turn off. If the reverse function is turned off at this point, the loop will continue in regular play. If the OUT/EXIT BUTTON (28) is pressed during reverse loop playback mode, playback will continue in reverse until the reverse function.

ADVANCED OPERATIONS

FLIP-FLOP™

This feature is a kind of “auto pilot.” “Flip-Flop” mode can only function with the both sides of the DCD-PRO600. The “Flip-Flop” function may be used with or without an American Audio® or American DJ® “Q” deck mixer. With “Flip-Flop” you can have one unit begin playback when the other ends. You can “Flip Flop” single tracks, the entire disc, a combination of the two, or you can even “Flip-Flop” your programmed tracks.

To FLIP-FLOP single tracks or programmed tracks:

- 1) Connect your system as described in the set up section on page 6.
- 2) Set your mixer’s crossfader to the center position.
- 3) Be sure your two units are single mode. SINGLE (67) should be indicated in the LCD (14).
- 4) Load your two DCD-PRO600 with audio disc.

- 5) After they have both cued, press the PLAY/PAUSE BUTTON (29) on one of your drive to begin playback.
- 6) After the first unit’s single track has ended the second unit’s track will immediately begin playback.
- 7) FLIP FLOP will continue until you stop it or power is interrupted.

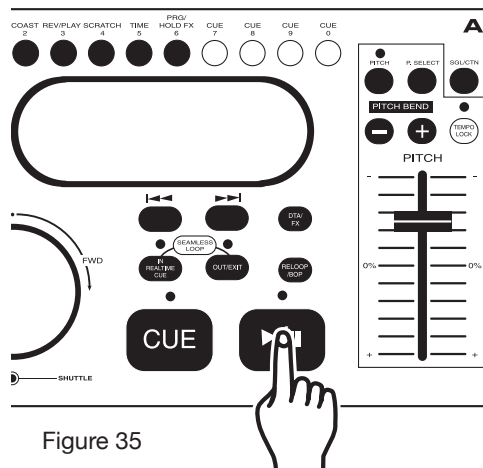

Figure 35

To FLIP-FLOP entire CDs:

To FLIP-FLOP an entire disc, be sure both drives are in continuous play mode. The SINGLE ICON (67) should not be displayed in the LCD (14). When both drives are in continuous play mode, follow the directions for single track FLIP-FLOP as detailed above. When one the disc in one unit ends the other unit will immediately begin playback.

Combining FLIP-FLOP modes:

Flip-Flop modes may combined. One unit may run in single mode and the other in continuous mode. When the units are arranged in this fashion, the unit in single mode will play a single track and flip to the next unit. The next unit will then play the entire disc and flip back to the other. The other will then play the next track and flip back to the other unit, and so on.

Fader Q-Start™

This function works in conjunction with a compatible American Audio® or American DJ® “Q-Start” mixer. When used with a compatible mixer, you can use the crossfader to start and stop the CD Player with the slide of the mixer’s crossfader.

Connecting your DCD-PRO600 to a “Q” Start mixer for “Q” Start control: Be sure to connect 1/8” mono mini plugs from the control connection on the rear your DCD-PRO600 to the 1/8” control jack on the rear of a American Audio® or American DJ® “Q” series mixer. That’s it, you’ll be set for “Q” Start!

Scratch Box™ Compatible

The optional American Audio® Scratch Box is a devices that simulates real time scratching of a CD. The Scratch Box™ device is used in conjunction with any turntable and any Scratch Box™ compatible American Audio® CD player. For details of the optional Scratch Box refer to page 28.

ADVANCED OPERATIONS

BUILT-IN EFFECTS: The DCD-PRO600™ comes with two built in effects. Only one effect may be used at any given time. The Built-in effects include FILTER and Coast. When either effect is activated a corresponding icon will display in the LCD. For example when the FILTER EFFECT (3) is activated a "1" (50) icon will display in the LCD (14). You can choose to use the effects with their default setting or you may choose activate the FILTER/COAST/ADJUST (1) function to increase the effect parameters (see below). Each effect has two sets of parameters. All parameters will be reset to there default values when power is shut off.

1. SCRATCH EFFECT - This button activates the SCRATCH effect. This effect can only be used in conjunction with the optional American Audio® Scratch Box.™ When the SCRATCH effect is engaged you may use any turntable to simulate real time scratch of any CD loaded in the CD transport. In actuality the turntable will simulate many functions such as scratching, start-up, stop, and power-off.

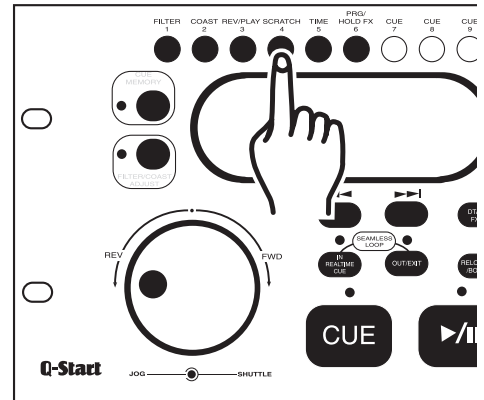
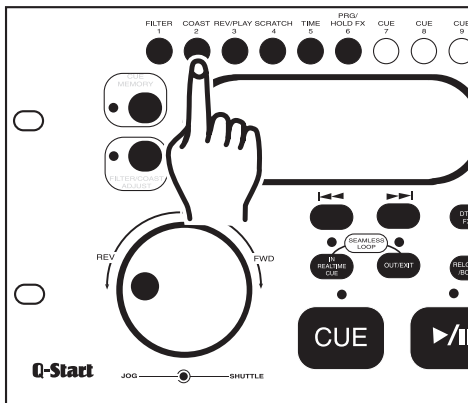

Figure 36



2. COAST EFFECT: This effect simulates turning the power off on a turntable, which cause a turntable platter to slowly spin down until it loses momentum and stops. The COAST effect may also be used to simulates a turntable slowly revving up to it's proper speed.

To activate the COAST effect be sure the DTA/FX BUTTON (22) (22) is off and press the COAST BUTTON (11). When the COAST effect is selected the "2" icon displays in the LCD (14).

Figure 37

3. COAST EFFECT Parameters: The coast effect parameters can be adjust to 10msec of second to 9.9 seconds. In effect this is the total time the effect will last. To adjust the effect parameters; Turn on the FILTER/COAST/ADJUST BUTTON (1). Once the FILTER/COAST/ADJUST function has been activated use the Jog Wheel to adjust the parameters. All parameters will return to their default settings once the unit has been powered down.

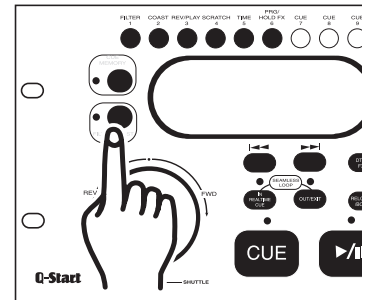

Figure 38

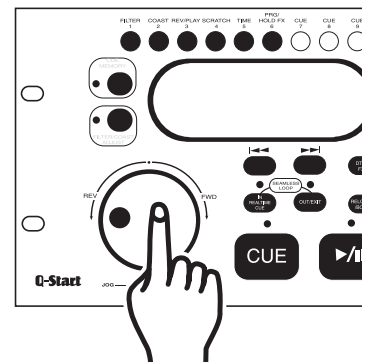
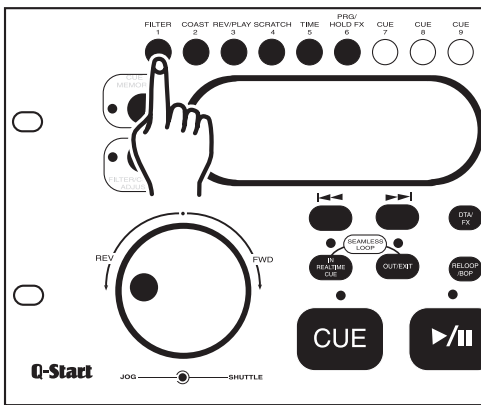

Figure 38

ADVANCED OPERATIONS (CONT)



FILTER EFFECT: The filter is a type of dampening effect that tweaks with the harmonics of a track. This effect uses a low and high filter to distort the an audio track. The effect works with both the low and high filters simultaneously.

To activate the FILTER effect be sure the DTA/FX BUTTON (22) is off and press the FILTER BUTTON (3). When the FILTER effect is selected the "1" icon displays in the LCD (14).

Figure 39

4. FILTER OPERATION - Once the filter has been engaged, use the PITCH SLIDER (23) to change the type of filter being applied. The filter parameters range from -12.7 to +12.7. The filter will automatically return to the default setting when you stop moving the PITCH SLIDER (23).

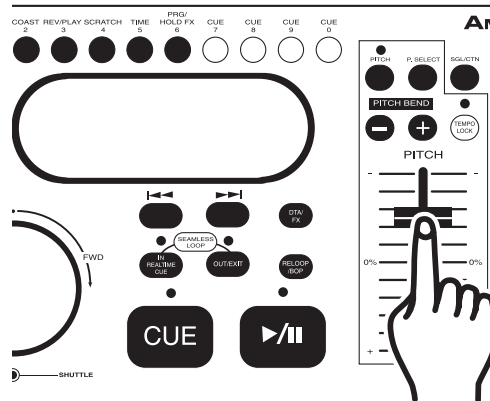
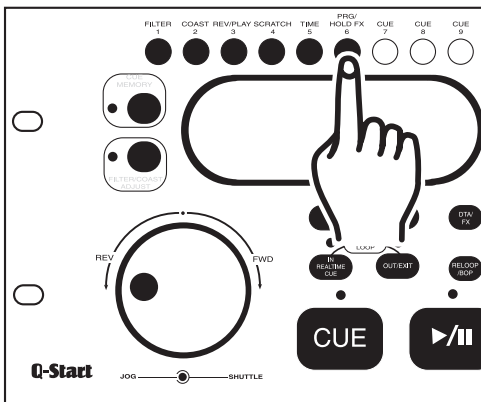

Figure 40



5. FILTER PARAMETER HOLD - To lock the filter at a specific parameter press the PRG/HOLD FX BUTTON (13). This will engage the hold function which will lock your desired filter parameter and set a new default value. Your default value will be erased once the unit is powered off.

Figure 41

6. FILTER LOOP FUNCTION - To lock the filter in a loop, press the FILTER/COAST/ADJUST BUTTON (1) while in the filter effect mode. This function will lock the filter effect in a continuous effect until the FILTER/COAST/ADJUST BUTTON (1) is disengaged.

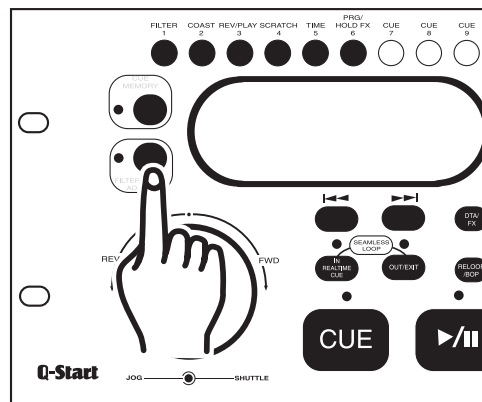
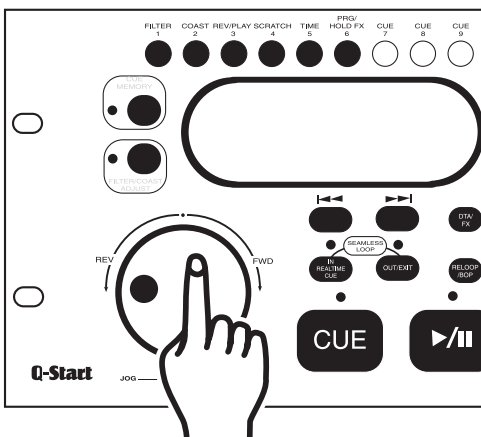

Figure 42



7. FILTER TIME PARAMETER - The filter effect has an adjustable time parameter of 10msec to 9.9 seconds. This is the amount of time it takes the filter to cycle through the low and high pass filters. This parameter can be adjusted at any time once the filter effect has been activated, by turning the jog wheel in either direction.

Figure 43

OPTIONAL SCRATCH BOX SET UP

Warning! Be sure to make all connections before powering the unit!

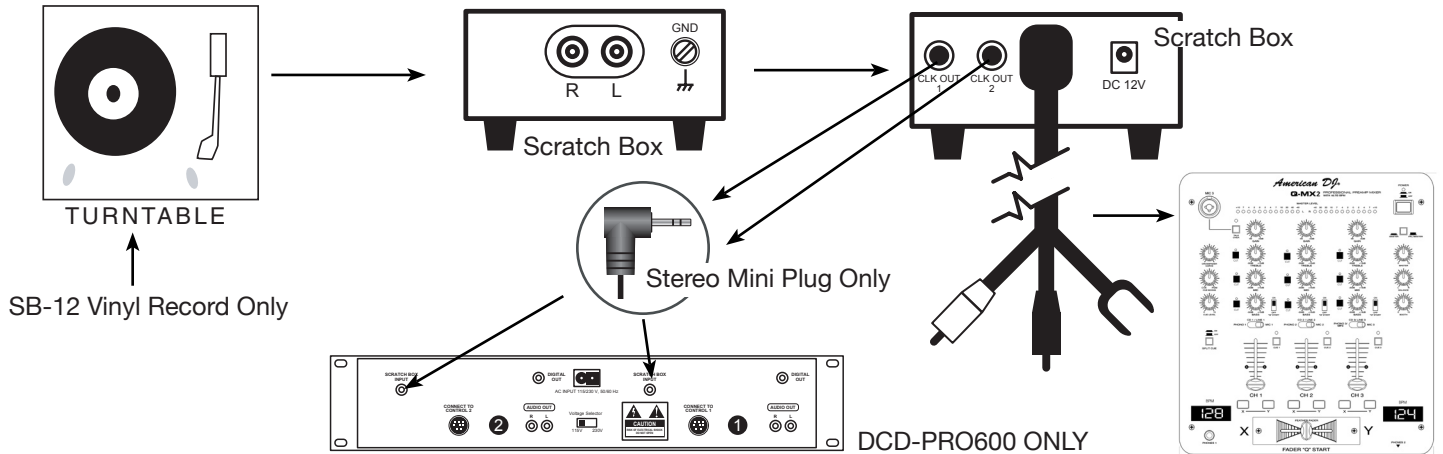

Scratch Box™ - The Scratch Box™ is compatible with any turntable. The above diagram briefly details set-up procedures. See page 26 for scratch effect.

Note: The Scratch Box™ will only function with the included SB-12 Blue Vinyl Record. Replacement Vinyl is available from American Audio.

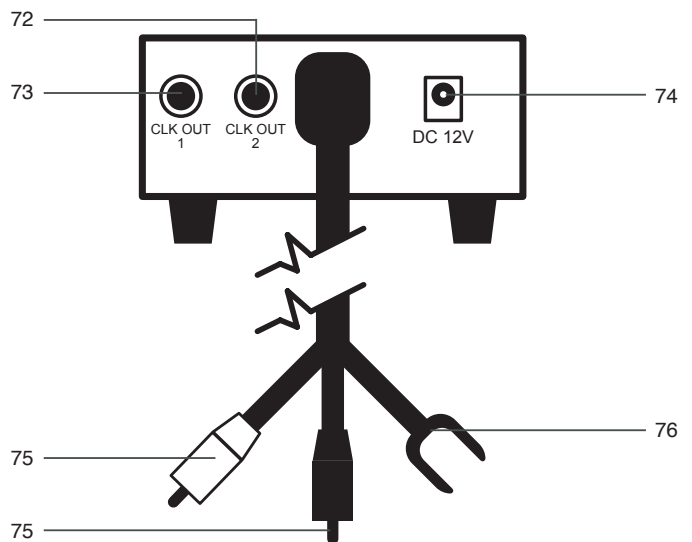
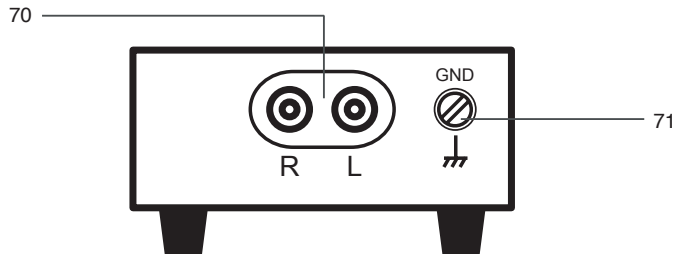

70. PHONO INPUTS - These are stereo phono inputs. Connect a turntable's output RCAs to these jacks. The right stereo channel is represented by the red female RCA and labeled with "R."

71. PHONO GROUND - This ground connector is used to extend the reach of the turntables ground connector. Connect the turntable ground cable to this connector to avoid hum and pops associated with phono cartridges.

72. CHANNEL 2 CONTROL OUTPUT - This control jack is used to send the signal coming from the turntable to the CD player. Connect this output to the channel two scratch box insert on the rear of the CD transport unit. Be sure to only use the supplied stereo mini plugs. Using mono mini plugs may cause your CD to play in reverse.

73. CHANNEL 1 CONTROL OUTPUT - This control jack is used to send the signal coming from the turntable to the CD player. Connect this output to the channel one scratch box insert on the rear of the CD transport unit. Be sure to only use the supplied stereo mini plugs. Using mono mini plugs may cause your CD to play in reverse.

74. POWER SUPPLY INPUT - Connect the power supply included with the unit to power the Scratch Box.™

75. PHONO OUTPUTS - These outputs are used to send the turntable analog signal to your mixer. The left channel is represented by the white RCA connector, the red represents the right channel.

76. GROUND OUTPUT - Connect the turntable ground cable to this connector to avoid hum and pops associated with phono cartridges.

BEFORE SWITCHING OFF THE POWER

- When you have finished using the CD unit, and before switching off the power, be sure that the disc holder has been closed with the OPEN/CLOSE button (see figures 7 & 8).
- TRAY PROTECTION: If tray is not closed after 60 seconds, it will close automatically and pause.

CAUTION: DO NOT forcibly close the disc holder when the power is off.

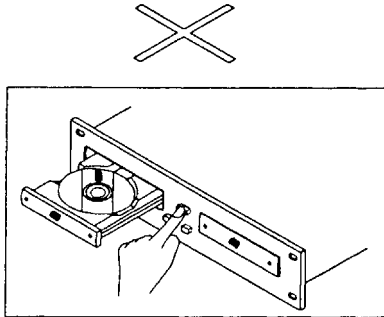

Do not switch off the power when the disc holder is open.

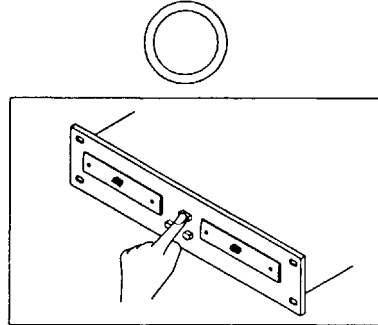

Switch off the power after the disc holder has been closed with the OPEN/CLOSE button.

DO NOT switch off the power when the disc holder is open. Switch off the power after the disc holder has been closed with the OPEN/CLOSE BUTTON (10).

COMPACT DISCS

1. PRECAUTIONS ON HANDLING COMPACT DISCS

Compact disc are constructed of the same types of plastic record are. To avoid severe damage to you valuable disc please observe the following guide lines. Following the these guide lines will ensure long disc life.

- Do not allow fingerprints, oil or dust to get on the surface of the disc. If the disc is dirty, wipe it off with a soft dry cloth.
- Do not use benzene, thinner, water, record spray, electrostatic-proof chemicals, or silicone-treated cloths to clean discs.
- Always handle discs carefully to prevent damaging the surface; in particular when removing a disc from the jewel case.
- Do not bend the disc.
- Do not apply heat.
- Do not enlarge the hole in the center of the disc.
- Do not write on the label (printed side) with a hard tipped implement such as a pencil or ball point pen.
- Condensation will form if a disc is brought into a warm area from a colder one, such as outdoors in winter. Do not attempt to dry the disc with a hair dryer, etc.

2. PRECAUTION ON STORAGE

- After playing a disc, always unload it from the unit.
- Always store the compact disc in the jewel case, protecting from dirt or damage.
- Do not place discs in the following areas:
 - a) Areas exposed to direct sunlight for a considerable time.
 - b) Areas subject to accumulation of dust or high humidity.
 - c) Areas affected by heat from indoor heaters, etc.

WARRANTY

2-YEAR LIMITED WARRANTY

A. American Audio® hereby warrants, to the original purchaser, American Audio® products to be free of manufacturing defects in material and workmanship for a period of 2 Year (730 days) from the date of purchase. This warranty shall be valid only if the product is purchased within the United States of America, including possessions and territories. It is the owner's responsibility to establish the date and place of purchase by acceptable evidence, at the time service is sought.

B. For warranty service, send the product only to the American Audio® factory. All shipping charges must be pre-paid. If the requested repairs or service (including parts replacement) are within the terms of this warranty, American Audio® will pay return shipping charges only to a designated point within the United States. If the entire instrument is sent, it must be shipped in its original package. No accessories should be shipped with the product. If any accessories are shipped with the product, American Audio® shall have no liability whatsoever for loss of or damage to any such accessories, nor for the safe return thereof.

C. This warranty is void if the serial number has been altered or removed; if the product is modified in any manner which American Audio® concludes, after inspection, affects the reliability of the product; if the product has been repaired or serviced by anyone other than the American Audio® factory unless prior written authorization was issued to purchaser by American Audio®; if the product is damaged because not properly maintained as set forth in the instruction manual.

D. This is not a service contract, and this warranty does not include maintenance, cleaning or periodic check-up. During the period specified above, American Audio® will replace defective parts at its expense, and will absorb all expenses for warranty service and repair labor by reason of defects in material or workmanship. The sole responsibility of American Audio® under this warranty shall be limited to the repair of the product, or replacement thereof, including parts, at the sole discretion of American Audio®. All products covered by this warranty were manufactured after January 1, 1990, and bear identifying marks to that effect.

E. American Audio® reserves the right to make changes in design and/or improvements upon its products without any obligation to include these changes in any products theretofore manufactured.

F. No warranty, whether expressed or implied, is given or made with respect to any accessory supplied with products described above. Except to the extent prohibited by applicable law, all implied warranties made by American Audio® in connection with this product, including warranties of merchantability or fitness, are limited in duration to the warranty period set forth above. And no warranties, whether expressed or implied, including warranties of merchantability or fitness, shall apply to this product after said period has expired. The consumer's and or Dealer's sole remedy shall be such repair or replacement as is expressly provided above; and under no circumstances shall American Audio® be liable for any loss or damage, direct or consequential, arising out of the use of, or inability to use, this product.

G. This warranty is the only written warranty applicable to American Audio® Products and supersedes all prior warranties and written descriptions of warranty terms and conditions heretofore published.

SPECIFICATIONS

GENERAL Model: American Audio® DCD-PRO600™ - Professional Compact Disc Player

System: Dual, CD Tray Loading, Digital Compact Disc Audio Player.

Disc type: Standard compact discs (5 in / 12cm and 3in/8cm discs)

Dimensions: Player unit: 19" (W) x 3 15/32" (H) x 9 55/64" (D)
482mm (W) x 88mm (H) x 264mm (D) (without feet)
Control unit: 19"(W) x 5 3/4" (H) x 1 37/64" (D)
482mm (W) x 132mm (H) x 74mm (D) (without feet)

Installation: Place on flat surface or mount in flat case

Weight: 5.3 Lbs. / 2.4 kgs

Power supply: AC 115v/230v, 50/60Hz

Power consumption: 25W

Pitch control range: +/-8%, +/-12%, +/-16%

Pitch bend: +/-16%

Pitch accuracy: +/- 0.1%

Environmental conditions: Operational temperature: 5 to 35°C (41 to 95°F)
Operational humidity: 25 to 85% RH (non-condensation)
Storage temperature: -20 to 60°C (4 to 140°F)

Accessories: Dual RCA Cable (for left and right channels)
Control 1/8" miniplug type (3 feet)

AUDIO SECTION

Quantization: 16 bit linear per channel

Sampling rate: 44.1 kHz at normal pitch

Over sampling rate: 8 times over sampling 1 bit D/A converter

D/A conversion: 16 bit

Frequency response: +/- 1 dB 20 Hz to 20,000 KHz

Output level: 2.0V +/- 1dB

Load impedance: 47k ohm or more

AUDIO CHARACTERISTICS (TEST DISC: TCD-782, LOAD=47Kohm)

ITEM	NOMINAL	LIMIT	CONDITION
Output level	2.0Vrms+/-1dB	2.0V+/-1dB	1KHz,0dB
Channel balance	0.5dB	1.0dB	1KHz,0dB
Frequency response	+/-0.5dB	+/-1.0dB	20Hz-20KHz,0dB
De-emphasis response	+/-2.5dB	+/-3dB	16KHz, -20dB
Channel separation*	82dB	75dB	1KHz,0dB
T.H.D. + NOISE*	0.02%	0.025%	1KHz,0dB
S/N ratio (IHF-A)*	84dB	75dB	1KHz.0dB

NOTE: *With 20KHz low pass filter.

SEARCHING TIME (TEST DISC: TCD-792)

ITEM	NOMINAL	LIMITS	CONDITION
Short access time	1.7 sec	4 sec	Play next track
Long access time	3 sec	6 sec	Track 1 ->Track 20 / Track 20 ->Track 1
CD recover time	1 sec	2 sec	CD play interrupted by mechanical shock

PLAYABILITY

ITEM	NOMINAL	LIMIT	CONDITION
Interruption	1000um	700um	TCD-725
Black dot	1000um	600um	TCD-725
Finger prints	75um	65um	TCD-725
Eccentricity	210um	140um	TCD-712,713 NO TRACK JUMP
Vertical deviation	1mm	0.54mm	TCD-731R

PICK-UP

System: Object lens drive system optical pick-up

Object lens drive system: 2 dimensional parallel drive

Tracking detection: 3 spot beam detection

Optical source: Semiconductor laser

Wave length: 780nm





©American Audio®
A Division of the American DJ® Group of Companies
American Audio® World Headquarters:
4295 Charter Street
Los Angeles, CA 90058 USA
Tel: 323-582-2650 Fax: 323-582-2610
Web: www.AmericanAudio.us E-mail: info@AmericanAudio.us