

Spectral distribution

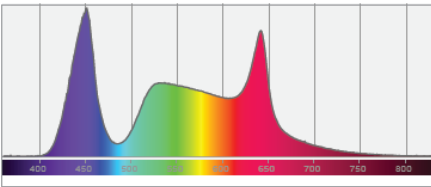

Color coordinates

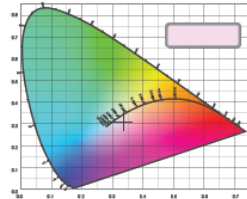

Zoom color point

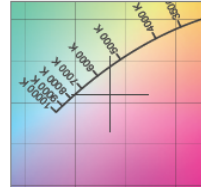

CRI R values

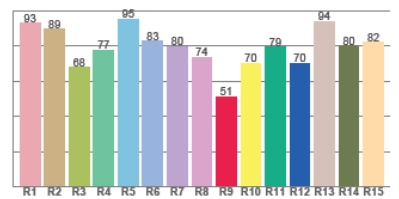

Photometric Test Report

*Due to additional product enhancements, an updated version of this report may be available online. Please check www.adj.com for the latest revision/update of this report.

MOD STQ



Light Efficiency:



Light Quality:



Color Temperature:



Output: 1673 lm

Peak: 11476 cd

Power: 55.0 W

PF: 0.65



Beam Angle

19.6°

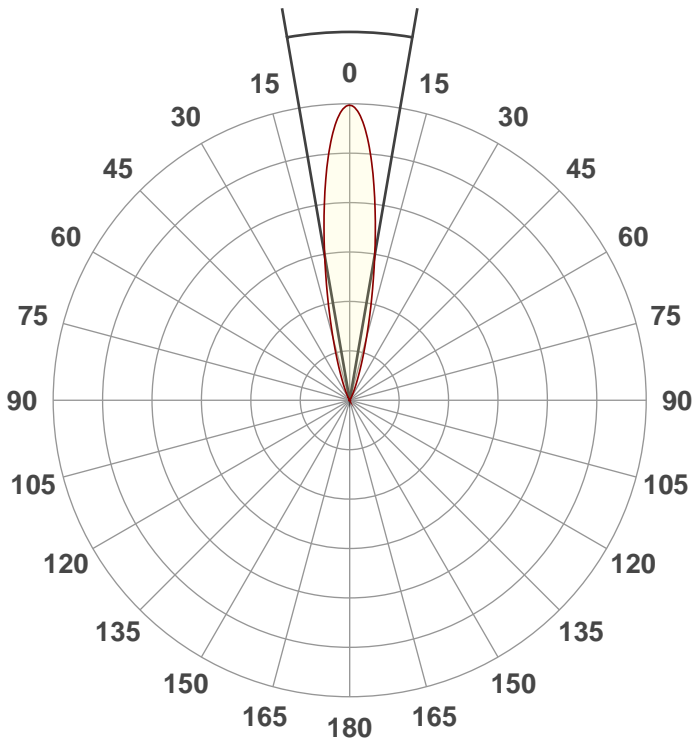

Test:

Full On

Date:

10/16/2019

Note:



CIE 1931
x: 0.258
y: 0.227

Spectra

Dominant Wavelength: 456nm

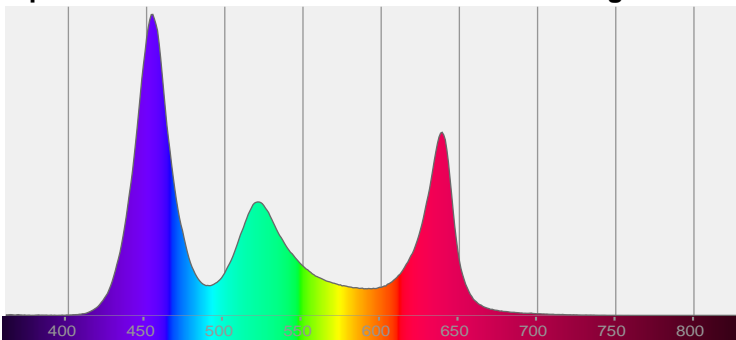

Power

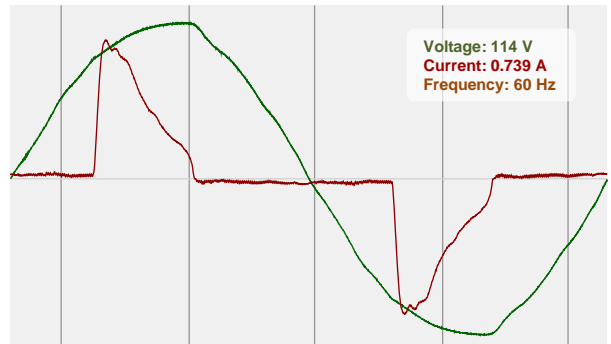

Color Details

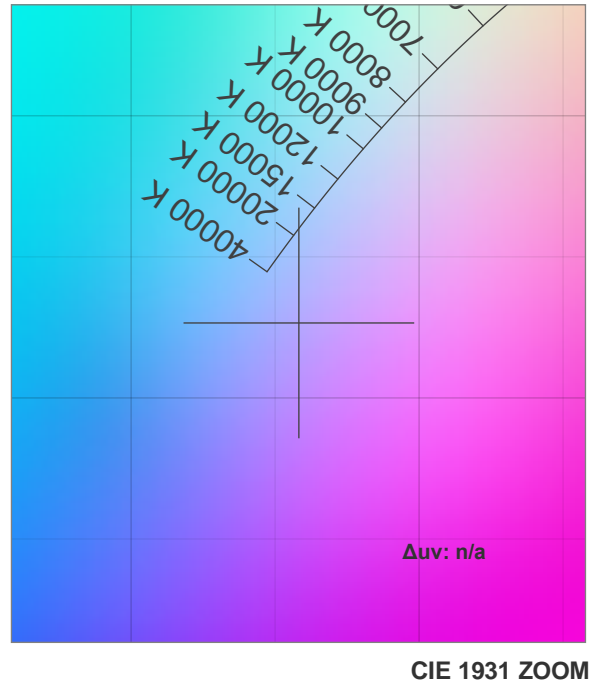
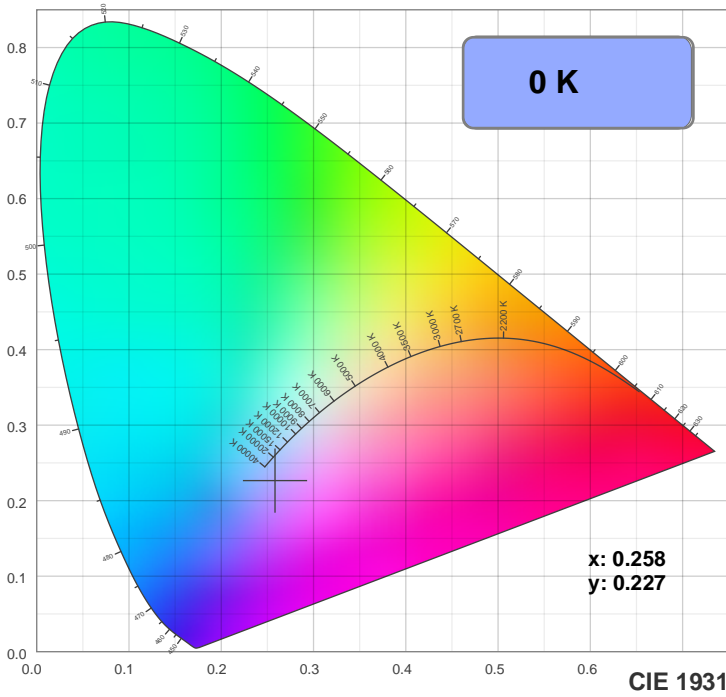

TM30: 0.0

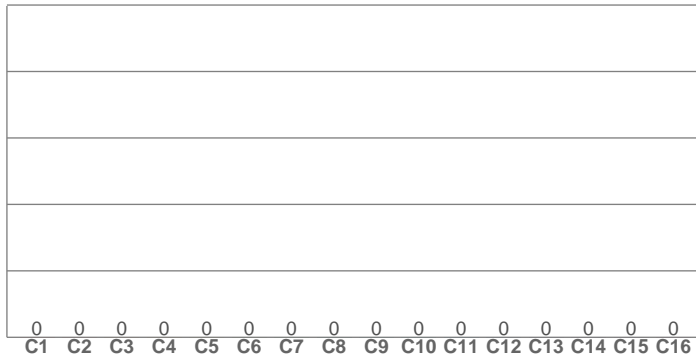

CRI R values, only R1-R8 are used to calculate final CRI value

R1	R2	R3	R4	R5	R6	R7	R8	R9	R10	R11	R12	R13	R14	R15
0.0	0.0	0.0	0.0	0.0	0.0	0.0	0.0	0.0	0.0	0.0	0.0	0.0	0.0	0.0

TM30 C values, 16 binned values out of total of 99 C values

C1	C2	C3	C4	C5	C6	C7	C8	C9	C10	C11	C12	C13	C14	C15	C16
0.0	0.0	0.0	0.0	0.0	0.0	0.0	0.0	0.0	0.0	0.0	0.0	0.0	0.0	0.0	0.0

CQS Q values

Q1	Q2	Q3	Q4	Q5	Q6	Q7	Q8	Q9	Q10	Q11	Q12	Q13	Q14	Q15
0.0	0.0	0.0	0.0	0.0	0.0	0.0	0.0	0.0	0.0	0.0	0.0	0.0	0.0	0.0

CRI: 0.0 (R1-R8)

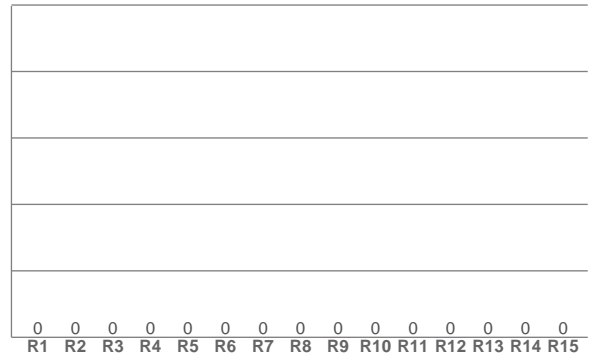

CQS: 0.0

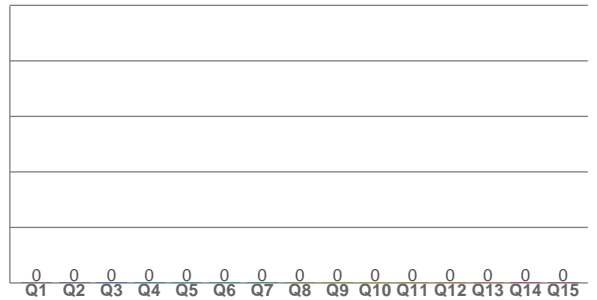

Color Parameters

Color Temperature	Color Rendering Index	Red Component	Color Fidelity	Color Gamut	Color Quality Scale	Color Coordinate CIE 1931	Color Coordinate CIE 1931	Color Coordinate	Color Coordinate	Color Deviation from Black Body
CCT	CRI	CRI R9	TM30 Rf	TM30 Rg	CQS	x	y	u	v	Δuv
0 K	0.0	0.0	0.0	0.0	0.0	0.258	0.227	0.199	0.261	n/a

Beam Details

Distance (meter)
Distance (feet)

1 2 3 4 5
3.3 6.6 9.8 13.1 16.4

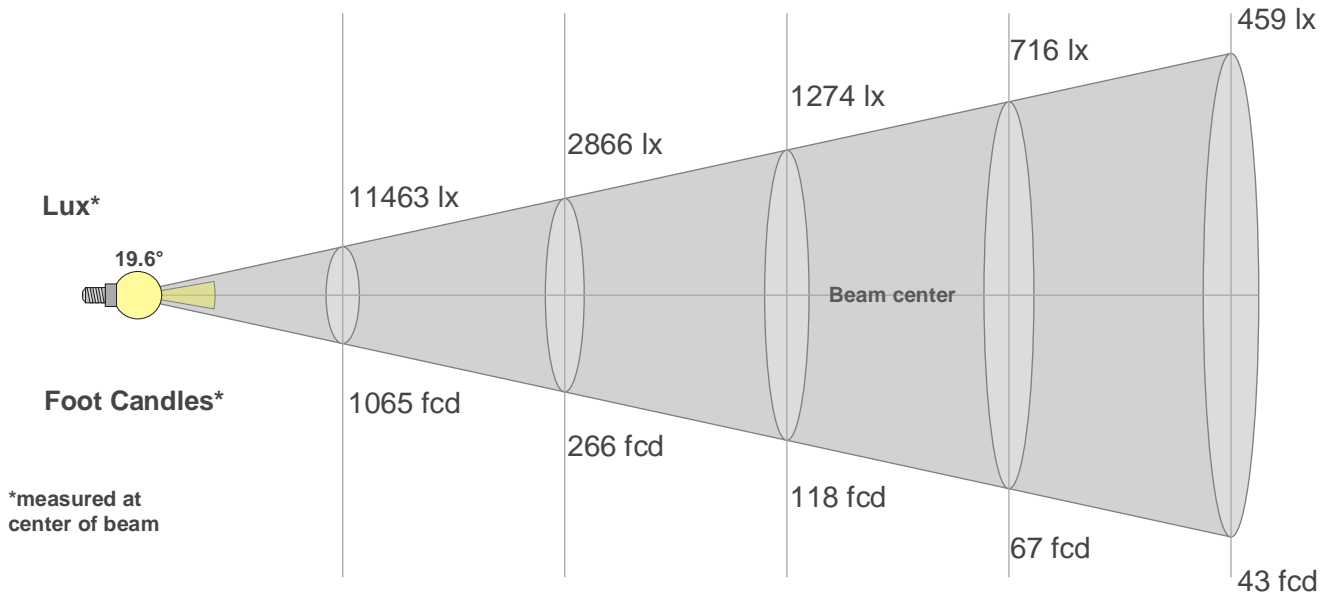

Beam Intensities from 1-20m

m	1	2	3	4	5	6	7	8	9	10	11	12	13	14	15	16	17	18	19	20
ft	3.3	6.6	9.8	13.1	16.4	19.7	23	26.2	29.5	32.8	36.1	39.4	42.7	45.9	49.2	52.5	55.8	59.1	62.3	65.6
lx	11463	2866	1274	716	459	318	234	179	142	115	95	80	68	58	51	45	40	35	32	29
fcd	1064.9	266.2	118.3	66.6	42.6	29.6	21.7	16.6	13.1	10.6	8.8	7.4	6.3	5.4	4.7	4.2	3.7	3.3	2.9	2.7

Intensities in 0° C-plane

0°	1°	2°	3°	4°	5°	6°	7°	8°	9°	10°	11°	12°	13°	14°	15°	16°	17°	18°	19°
11.5K	11.4K	11.1K	10.7K	10.2K	9.5K	8.8K	8.0K	7.2K	6.4K	5.6K	4.8K	4.2K	3.5K	3.0K	2.5K	2.1K	1.7K	1.4K	1.1K
100%	99%	97%	94%	89%	83%	77%	70%	63%	56%	49%	42%	36%	31%	26%	22%	18%	15%	12%	10%

Intensities in 90° C-plane

0°	1°	2°	3°	4°	5°	6°	7°	8°	9°	10°	11°	12°	13°	14°	15°	16°	17°	18°	19°
11.5K	11.4K	11.1K	10.7K	10.2K	9.5K	8.8K	8.0K	7.2K	6.4K	5.6K	4.8K	4.2K	3.5K	3.0K	2.5K	2.1K	1.7K	1.4K	1.1K
100%	99%	97%	94%	89%	83%	77%	70%	63%	56%	49%	42%	36%	31%	26%	22%	18%	15%	12%	10%

Intensities in 180° C-plane

0°	1°	2°	3°	4°	5°	6°	7°	8°	9°	10°	11°	12°	13°	14°	15°	16°	17°	18°	19°
11.5K	11.4K	11.1K	10.7K	10.1K	9.5K	8.7K	8.0K	7.2K	6.4K	5.6K	4.8K	4.2K	3.6K	3.0K	2.5K	2.1K	1.8K	1.4K	1.2K
100%	99%	97%	93%	89%	83%	76%	69%	62%	56%	49%	42%	36%	31%	26%	22%	18%	15%	13%	10%

Intensities in 270° C-plane

0°	1°	2°	3°	4°	5°	6°	7°	8°	9°	10°	11°	12°	13°	14°	15°	16°	17°	18°	19°
11.5K	11.4K	11.1K	10.7K	10.1K	9.5K	8.7K	8.0K	7.2K	6.4K	5.6K	4.8K	4.2K	3.6K	3.0K	2.5K	2.1K	1.8K	1.4K	1.2K
100%	99%	97%	93%	89%	83%	76%	69%	62%	56%	49%	42%	36%	31%	26%	22%	18%	15%	13%	10%

Beam Angle 50%	Field Angle 10%	Cutoff Angle 2,5%	Intensity Ratio in 120° Cone	Intensity Ratio in 90° Cone
19.6°	38.2°	50.8°	100.0%	99.9%