

Spectral distribution

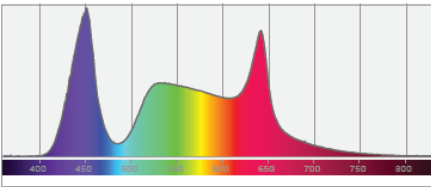

Color coordinates

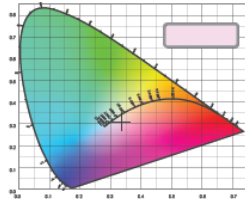

Zoom color point

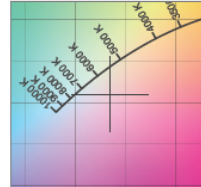

CRI R values

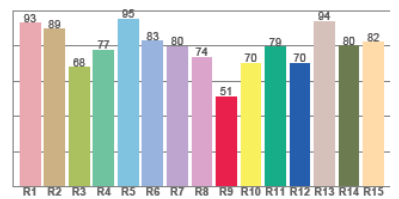

Photometric Test Report

*Due to additional product enhancements, an updated version of this report may be available online. Please check www.adj.com for the latest revision/update of this report.



Light efficiency:

40 Lumen/Watt

Light quality:

CRI: 85.1

Color temperature:

7271 K

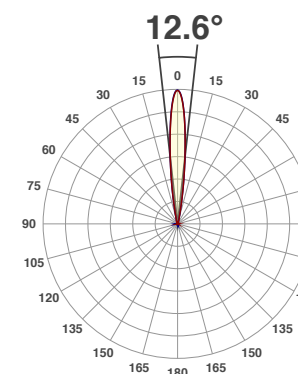

Product name:
MOD TW100

Test:
CW

Date:
10/11/2017

Output: 2124 lm Power consumption: 53.0 W Peak: 30493 cd

Spectral distribution

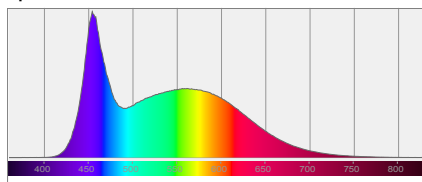

Color coordinates

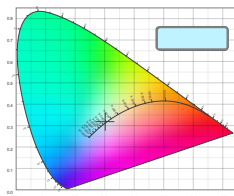

Zoom color point

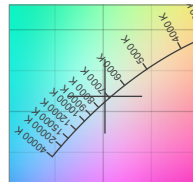

CRI R values

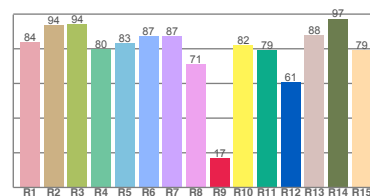

Color temperature	Color rendering index	Red component	Color fidelity	Color gamut	Color quality scale	Color coordinate cie 1931	Color coordinate cie 1931	Color coordinate	Color coordinate	Color divition from black body
CCT	CRI	CRI R9	TM30 Rf	TM30 Rg	CQS	x	y	u	v	Δuv
7271 K	85.1	17.1	81.1	91.8	81.5	0.302	0.319	0.194	0.307	0.0003

Beam details

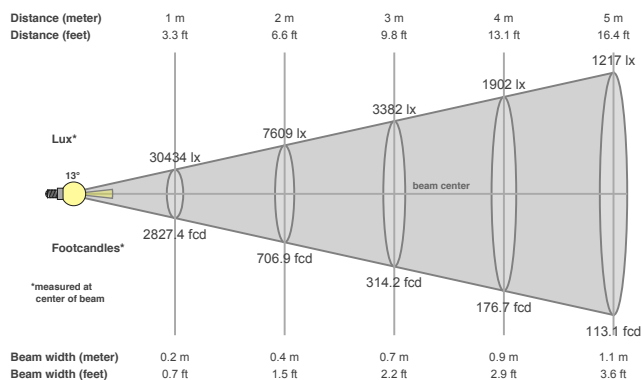

Beam angles

Beam angle 50%	Field angle 10%	Cutoff angle 2,5%
12.6°	23.3°	37.5°

Beam intensities

Peak intensity	Int. ratio in 120° cone	Int. ratio in 90° cone
30493 cd	98.6%	97.1%

Power

Power	Power factor	Power frequency
53.0 W	0.58	60 Hz

Nominal voltage	Voltage	Current
230 V	115 V	0.801 A

Beam intensities from 1-20m

1m	2m	3m	4m	5m	6m	7m	8m	9m	10m	11m	12m	13m	14m	15m	16m	17m	18m	19m	20m
3.3ft	6.6ft	9.8ft	13.1ft	16.4ft	19.7ft	23ft	26.2ft	29.5ft	32.8ft	36.1ft	39.4ft	42.7ft	45.9ft	49.2ft	52.5ft	55.8ft	59.1ft	62.3ft	65.6ft
30434lx	7609lx	3382lx	1902lx	1217lx	845lx	621lx	476lx	376lx	304lx	252lx	211lx	180lx	155lx	135lx	119lx	105lx	94lx	84lx	76lx
2827.4fcd	706.9fcd	314.2fcd	176.7fcd	113.1fcd	78.5fcd	57.7fcd	44.2fcd	34.9fcd	28.3fcd	23.4fcd	19.6fcd	16.7fcd	14.4fcd	12.6fcd	11fcd	9.8fcd	8.7fcd	7.8fcd	7.1fcd



Light efficiency:

35 Lumen/Watt

Light quality:

CRI: 84.9

Color temperature:

4932 K

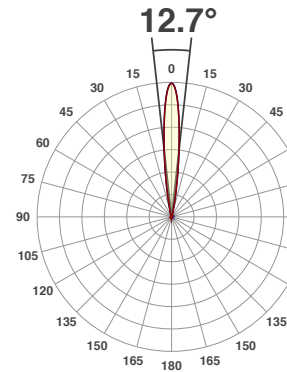

Product name:

MOD TW100

Test:

CW WW

Date:

10/11/2017

Output: 3532 lm Power consumption: 100 W Peak: 49793 cd

Spectral distribution

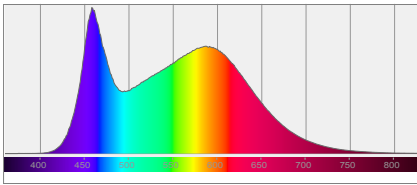

Color coordinates

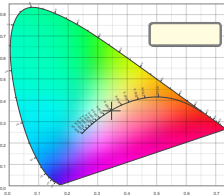

Zoom color point

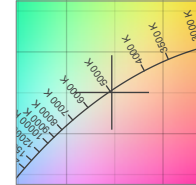

CRI R values

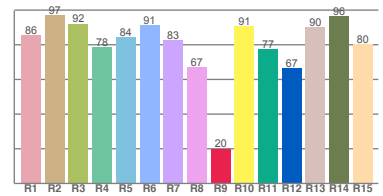

Color temperature	Color rendering index	Red component	Color fidelity	Color gamut	Color quality scale	Color coordinate cie 1931	Color coordinate cie 1931	Color coordinate	Color coordinate	Color divition from black body
CCT	CRI	CRI R9	TM30 Rf	TM30 Rg	CQS	x	y	u	v	Δuv
4932 K	84.9	20.1	80.4	90.6	82.2	0.347	0.350	0.213	0.323	0.0021

Beam details

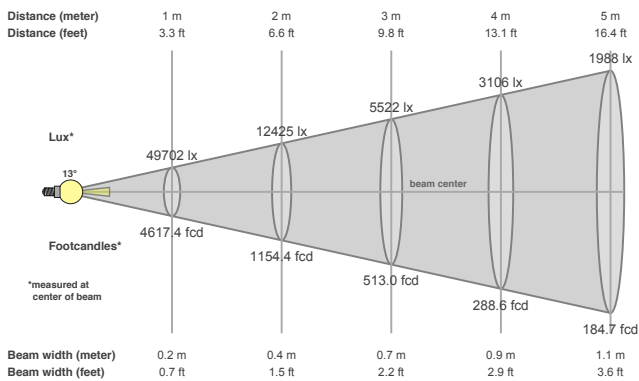

Beam angles

Beam angle 50%	Field angle 10%	Cutoff angle 2,5%
12.7°	23.4°	37.8°

Beam intensities

Peak intensity	Int. ratio in 120° cone	Int. ratio in 90° cone
49793 cd	98.2%	96.4%

Power

Power	Power factor	Power frequency
100 W	0.64	60 Hz

Nominal voltage	Voltage	Current
230 V	114 V	1.38 A

Beam intensities from 1-20m

1m	2m	3m	4m	5m	6m	7m	8m	9m	10m	11m	12m	13m	14m	15m	16m	17m	18m	19m	20m
3.3ft	6.6ft	9.8ft	13.1ft	16.4ft	19.7ft	23ft	26.2ft	29.5ft	32.8ft	36.1ft	39.4ft	42.7ft	45.9ft	49.2ft	52.5ft	55.8ft	59.1ft	62.3ft	65.6ft
49702lx	12425lx	5522lx	3106lx	1988lx	1381lx	1014lx	777lx	614lx	497lx	411lx	345lx	294lx	254lx	221lx	194lx	172lx	153lx	138lx	124lx
4617.4fcd	1154.4fcd	513fcd	288.6fcd	184.7fcd	128.3fcd	94.2fcd	72.1fcd	57fcd	46.2fcd	38.2fcd	32.1fcd	27.3fcd	23.6fcd	20.5fcd	18fcd	16fcd	14.3fcd	12.8fcd	11.5fcd



Light efficiency:

36 Lumen/Watt

Light quality:

CRI: 79.9

Color temperature:

3181 K

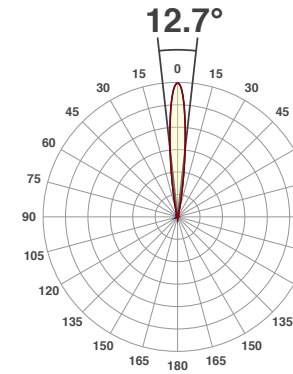

Product name:
MOD TW100

Test:
WW

Date:
10/11/2017

Output: 1890 lm Power consumption: 52.9 W Peak: 26449 cd

Spectral distribution

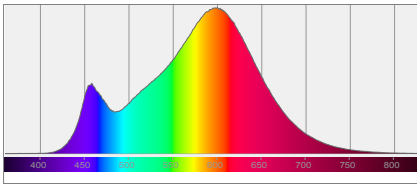

Color coordinates

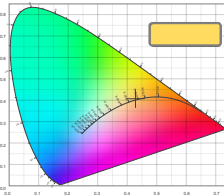

Zoom color point

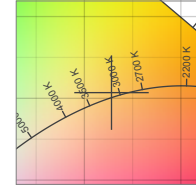

CRI R values

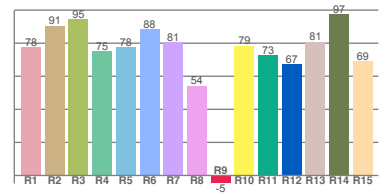

Color temperature	Color rendering index	Red component	Color fidelity	Color gamut	Color quality scale	Color coordinate cie 1931	Color coordinate cie 1931	Color coordinate	Color coordinate	Color deviation from black body
CCT	CRI	CRI R9	TM30 Rf	TM30 Rg	CQS	x	y	u	v	Δuv
3181 K	79.9	-4.8	80.4	91.0	80.0	0.428	0.407	0.244	0.347	0.0025

Beam details

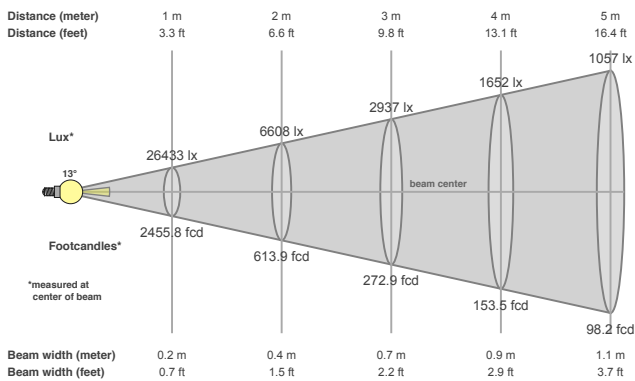

Beam angles

Beam angle 50%	Field angle 10%	Cutoff angle 2,5%
12.7°	23.6°	38.2°

Beam intensities

Peak intensity	Int. ratio in 120° cone	Int. ratio in 90° cone
26449 cd	98.5%	96.9%

Power

Power	Power factor	Power frequency
52.9 W	0.58	60 Hz

Nominal voltage	Voltage	Current
230 V	114 V	0.807 A

Beam intensities from 1-20m

1m	2m	3m	4m	5m	6m	7m	8m	9m	10m	11m	12m	13m	14m	15m	16m	17m	18m	19m	20m
3.3ft	6.6ft	9.8ft	13.1ft	16.4ft	19.7ft	23ft	26.2ft	29.5ft	32.8ft	36.1ft	39.4ft	42.7ft	45.9ft	49.2ft	52.5ft	55.8ft	59.1ft	62.3ft	65.6ft
26433lx	6608lx	2937lx	1652lx	1057lx	734lx	539lx	413lx	326lx	264lx	218lx	184lx	156lx	135lx	117lx	103lx	91lx	82lx	73lx	66lx
2455.8fcd	613.9fcd	272.9fcd	153.5fcd	98.2fcd	68.2fcd	50.1fcd	38.4fcd	30.3fcd	24.6fcd	20.3fcd	17.1fcd	14.5fcd	12.5fcd	10.9fcd	9.6fcd	8.5fcd	7.6fcd	6.8fcd	6.1fcd