



**DP-640B™**  
user manual

©2016 **ELATION PROFESSIONAL** all rights reserved. Information, specifications, diagrams, images, and instructions herein are subject to change without notice. ELATION PROFESSIONAL logo and identifying product names and numbers herein are trademarks of ELATION PROFESSIONAL. Copyright protection claimed includes all forms and matters of copyrightable materials and information now allowed by statutory or judicial law or hereinafter granted. Product names used in this document may be trademarks or registered trademarks of their respective companies and are hereby acknowledged. All non-ELATION brands and product names are trademarks or registered trademarks of their respective companies.

**ELATION PROFESSIONAL** and all affiliated companies hereby disclaim any and all liabilities for property, equipment, building, and electrical damages, injuries to any persons, and direct or indirect economic loss associated with the use or reliance of any information contained within this document, and/or as a result of the improper, unsafe, insufficient and negligent assembly, installation, rigging, and operation of this product.

**Elation Professional USA** | 6122 S. Eastern Ave. | Los Angeles, CA. 90040  
323-582-3322 | 323-832-9142 fax | [www.elationlighting.com](http://www.elationlighting.com) | [info@elationlighting.com](mailto:info@elationlighting.com)

**Elation Professional B.V.** | Junostraat 2 | 6468 EW Kerkrade, The Netherlands  
+31 45 546 85 66 | +31 45 546 85 96 fax | [www.elationlighting.eu](http://www.elationlighting.eu) | [info@elationlighting.eu](mailto:info@elationlighting.eu)

## **DOCUMENT VERSION**



Please check [www.elationlighting.com](http://www.elationlighting.com) for the latest revision/update of this manual.

<b>Date</b>	<b>Document Version</b>	<b>Notes</b>
05/05/16	2	Updated user manual format.

## CONTENTS

General Information	4
Warranty	6
Safety Instructions	7
General Guidelines	8
Device Overview	9
Device Operation	10
Trouble Shooting	16
Maintenance	17
Technical Specifications	18
Optional Accessories	19

## **GENERAL INFORMATION**

### **INTRODUCTION**

This device has been designed to perform reliably for years when the guidelines in this booklet are followed. Please read and understand the instructions in this manual carefully and thoroughly before attempting to operate this device. These instructions contain important information regarding safety during use and maintenance.

### **UNPACKING**

Every device has been thoroughly tested and has been shipped in perfect operating condition. Carefully check the shipping carton for damage that may have occurred during shipping. If the carton appears to be damaged, carefully inspect your unit for damage and be sure all accessories necessary to operate the unit have arrived intact. In the event damage has been found or parts are missing, please contact our customer support team for further instructions. Please do not return this unit to your dealer without first contacting customer support at the number listed below. Please do not discard the shipping carton in the trash. Please recycle whenever possible.

### **BOX CONTENTS**

- Hanging Bracket & Screws
- Manual & Warranty Card

## **CUSTOMER SUPPORT**

Elation Professional® provides a customer support line, to provide set up help and to answer any question should you encounter problems during your set up or initial operation. You may also visit us on the web at [www.elationlighting.com](http://www.elationlighting.com) for any comments or suggestions. For service related issue please contact Elation Professional®.

### **ELATION SERVICE USA - Monday - Friday 8:00am to 5:00pm PST**

**Voice: 323-582-3322**

**Fax: 323-832-9142**

E-mail: [support@elationlighting.com](mailto:support@elationlighting.com)

### **ELATION SERVICE EUROPE - Monday - Friday 08:30 to 17:00 CET**

**Voice: +31 45 546 85 30**

**Fax: +31 45 546 85 96**

E-mail: [support@elationlighting.eu](mailto:support@elationlighting.eu)

## **WARRANTY REGISTRATION**

Please complete and mail in the enclosed warranty card or register online: <http://www.elationlighting.com/Login.aspx> to validate your purchase. All returned service items whether under warranty or not, must be freight pre-paid and accompany a return authorization (R.A.) number. The R.A. number must be clearly written on the outside of the return package. A brief description of the problem as well as the R.A. number must also be written down on a piece of paper and included in the shipping container. If the unit is under warranty, you must provide a copy of your proof of purchase invoice. Items returned without a R.A. number clearly marked on the outside of the package will be refused and returned at customer's expense. You may obtain a R.A. number by contacting customer support.

## **IMPORTANT NOTICE!**

**There are no user serviceable parts inside this unit. Do not attempt any repairs yourself; doing so will void your manufactures warranty. Damages resulting from modifications to this fixture and/or the disregard of safety and general user instructions found in this user manual void the manufactures warranty and are not subject to any warranty claims and/or repairs.**

## LIMITED WARRANTY

A. Elation Professional® hereby warrants, to the original purchaser, Elation Professional® products to be free of manufacturing defects in material and workmanship for a period of two years (730 days), and Elation Professional® product rechargeable batteries to be free of manufacturing defects in material and workmanship for a period of six months (180 days), from the original date of purchase. This warranty excludes discharge lamps and all product accessories. This warranty shall be valid only if the product is purchased within the United States of America, including possessions and territories. It is the owner's responsibility to establish the date and place of purchase by acceptable evidence, at the time service is sought.

B. For warranty service, send the product only to the Elation Professional® factory. All shipping charges must be pre-paid. If the requested repairs or service (including parts replacement) are within the terms of this warranty, Elation Professional® will pay return shipping charges only to a designated point within the United States. If any product is sent, it must be shipped in its original package and packaging material. No accessories should be shipped with the product. If any accessories are shipped with the product, Elation Professional® shall have no liability what so ever for loss and/or or damage to any such accessories, nor for the safe return thereof.

C. This warranty is void if the product serial number and/or labels are altered or removed; if the product is modified in any manner which Elation Professional® concludes, after inspection, affects the reliability of the product; if the product has been repaired or serviced by anyone other than the Elation Professional® factory unless prior written authorization was issued to purchaser by Elation Professional®; if the product is damaged because not properly maintained as set forth in the product instructions, guidelines and/or user manual.

D. This is not a service contract, and this warranty does not include any maintenance, cleaning or periodic check-up. During the periods as specified above, Elation Professional® will replace defective parts at its expense, and will absorb all expenses for warranty service and repair labor by reason of defects in material or workmanship. The sole responsibility of Elation Professional® under this warranty shall be limited to the repair of the product, or replacement thereof, including parts, at the sole discretion of Elation Professional®. All products covered by this warranty were manufactured after January 1, 1990, and bare identifying marks to that effect.

E. Elation Professional® reserves the right to make changes in design and/or performance improvements upon its products without any obligation to include these changes in any products theretofore manufactured.

F. No warranty, whether expressed or implied, is given or made with respect to any accessory supplied with the products described above. Except to the extent prohibited by applicable law, all implied warranties made by Elation Professional® in connection with this product, including warranties of merchantability or fitness, are limited in duration to the warranty periods set forth above. And no warranties, whether expressed or implied, including warranties of merchantability or fitness, shall apply to this product after said periods have expired. The consumer's and/or dealer's sole remedy shall be such repair or replacement as is expressly provided above; and under no circumstances shall Elation Professional® be liable for any loss and/or damage, direct and/or consequential, arising out of the use of, and/or the inability to use, this product.

G. This warranty is the only written warranty applicable to Elation Professional® products and supersedes all prior warranties and written descriptions of warranty terms and conditions heretofore published.

## SAFETY INSTRUCTIONS



This fixture is an extremely sophisticated piece of electronic equipment. To guarantee a smooth operation, it is important to follow the guidelines in this manual. The manufacturer of this device will not accept responsibility for damages resulting from the misuse of this fixture due to the disregard of the information printed in this manual.



This device falls under **PROTECTION CLASS 1**. It's essential this device be grounded properly. Only qualified personnel should perform all electrical connections.



**I N D O O R S U S E O N L Y !**  
**DO NOT EXPOSE DEVICE TO RAIN AND MOISTURE!**



**UNPLUG POWER BEFORE SERVICING FIXTURE!**  
**DO NOT PLUG DEVICE INTO A DIMMER PACK!**

- For proper operation, follow the **Installation** guidelines described in this manual. Only qualified and certified personnel should perform installation of this device and only the original rigging hardware (brackets) included with this device should be used for installation. Any modifications will void the original manufactures warranty and increase the risk of damage and/or personal injury.
- Always disconnect from main power source before performing any type of service and/or cleaning procedure. Only handle the power cord by the plug end, never pull out the plug by tugging the wire portion of the cord.
- Do not operate this fixture if the power cord has become frayed, crimped and/or damaged. If the power cord is damaged, replace it immediately with a new one of similar power rating.



### **FLAMMABLE MATERIAL WARNING**

**Keep fixture at least 5.0 ft (1.5m) away from any flammable materials, decorations, pyrotechnics, etc.**



### **ELECTRICAL CONNECTIONS**

**A qualified electrician should be used for all electrical connections and/or installations.**

## GENERAL GUIDELINES

- **NEVER OPEN THIS DEVICE WHILE IN USE!**
- This is a professional device designed for **INDOOR / DRY LOCATIONS ONLY** on stage, in nightclubs, theatres, etc.
- Please make sure there are **NO FLAMMABLE MATERIALS** close to the device while operating, to prevent any fire hazard.
- **DO NOT** attempt installation and/or operation without knowledge how to do so.
- **DO NOT** permit operation by persons who are not qualified to operate this type of device. Most damages are the result of operations by nonprofessionals.
- **DO NOT** shake device, avoid brute force when installing and/or operating.
- Use the original packaging and materials to transport the device in for service.



## DEVICE OVERVIEW

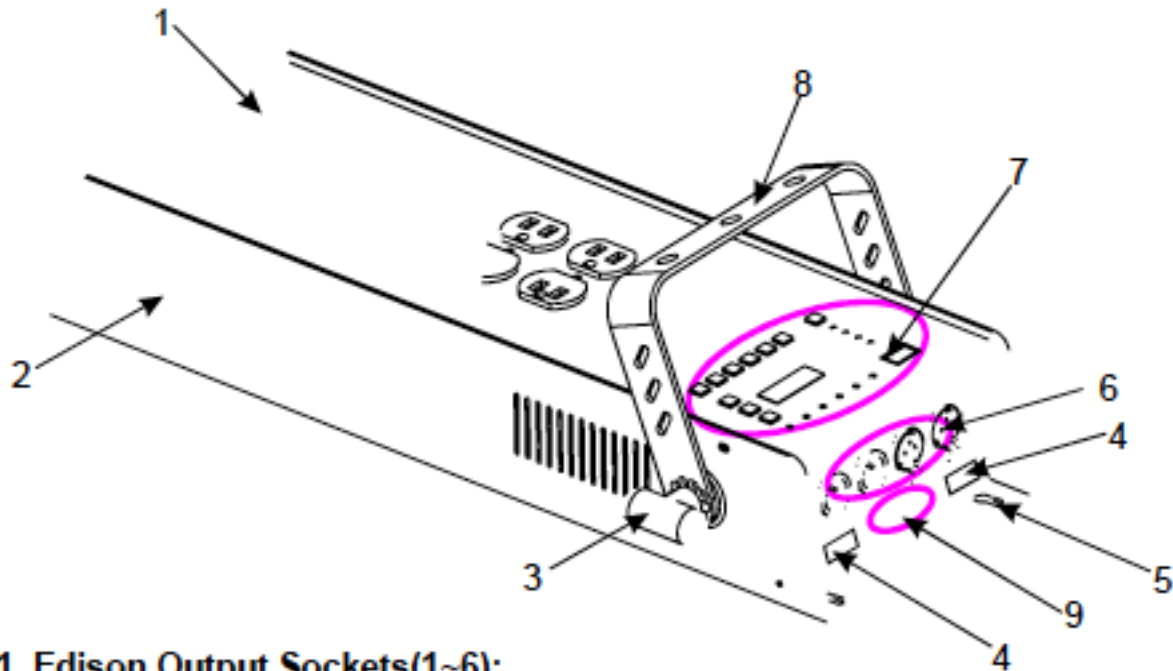

1. **Edison Output Sockets(1~6):**  
These are dual 120V Edison sockets for output. Each socket is labeled with the relevant channel number. Up to 20Amps can be connected into each channel.
2. **Threaded Openings:**  
These openings are supplied so the user can fasten the mounting bracket to the desired side.
3. **Bracket Knobs:**  
These knobs are used to fasten the hanging bracket to the chassis.
4. **Resettable Circuit Breakers(x2pcs):**  
These two 20A circuit breakers, protect the corresponding internal components from damage if there were ever a short circuit or voltage spike.
5. **Mounting Slots:**  
These slots are in place so the user could permanently mount the unit if desired.
6. **Connectors:**  
These are the DMX Input/Output connectors. There are 3 & 5 pin XLR inputs and outputs.
7. **Control Section:**  
These buttons are used to adjust relevant settings within the display.
8. **Mounting Bracket:**  
This mounting bracket is used to fasten the unit to a truss structure.
9. **Power Inputs:**  
These supply power to the relevant channels when connect. Line cord 1 supplies power to channels 1-3 and line cord 2 to channels 4-6.

## DEVICE OPERATION

### Data & Power Connections

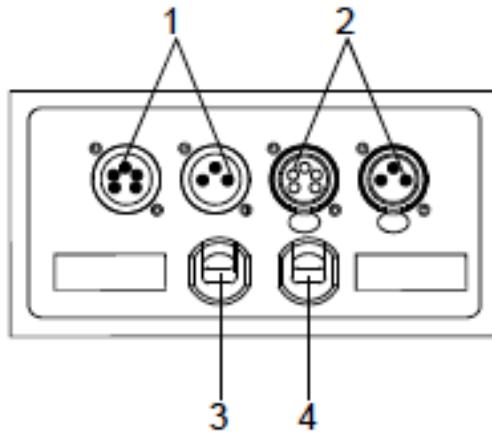

1. **DMX IN:**  
3 & 5 Pin (male) input socket.
2. **DMX OUT:**  
3 & 5 Pin (female) output socket.
3. **Power 1:**  
Power cord 1- powers channels 1~3, 2400 watts.
4. **Power 2:**  
Power cord 2- powers channels 4~6, 2400 watts.

### LED-display & Control buttons

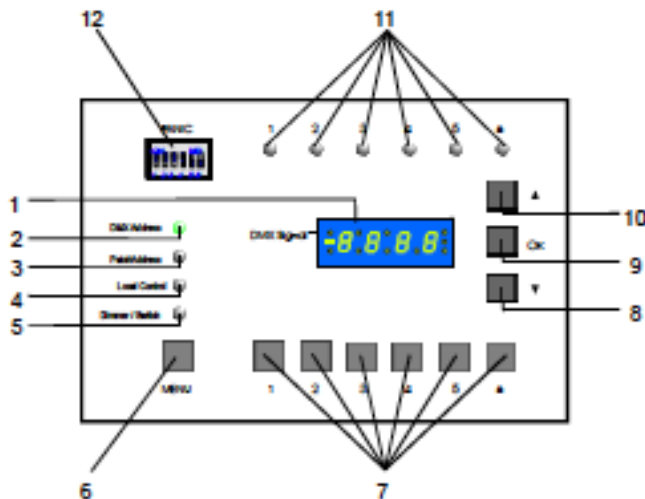

1. **LED-display:** displays the current value and function mode-including a DMX signal indicator.
2. **DMX Address LED:** this LED illuminates when in DMX mode.
3. **Patch Address LED:** this LED illuminates when in Patch mode.
4. **Local Control LED:** this LED illuminates when in Manual Control mode.
5. **Dimmer/Switch LED:** this LED illuminates when assigning dim/switch modes.
6. **Menu Button:** The menu button allows you navigate through function modes.
7. **Channel Buttons 1~6:** These buttons are used to select relevant channels.
8. **Down Button:** This button decreases values and selects desired function modes.
9. **OK Button:** This button confirms and saves relevant settings.
10. **UP Button:** This button increases values and selects desired function modes.
11. **Channel 1~6 LEDs:** Indicate output for relevant channels.
12. **Panic dip-switches:** These switches are used to activate selected channels to full ON when DMX signal is not present.

**\*Note:** Abbreviations within the display represent the following:

A=Address, C=Channel, d= Display, s=Switch.

Press the MENU button to navigate through the menu options. Continually pressing the MENU button will loop through the four options as illustrated below. When in each function mode, its LED will illuminate.



## Function Mode 1: DMX Address (Block)

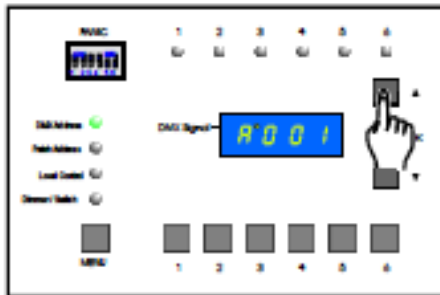

(1) This function is used when setting the starting DMX address channel for the pack. Use the UP/DOWN buttons to adjust to a desired setting. The selected DMX channel will be the DMX starting address for the pack. A total of six DMX channels will be occupied by the DP-640B in sequence, starting with the set channel.

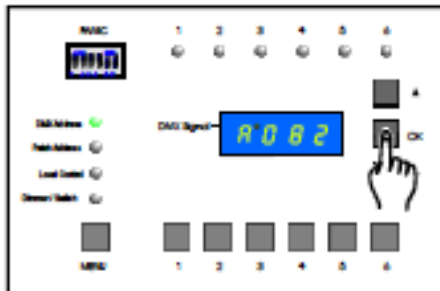

(2) Press the "OK" button to confirm and save your setting, the LED-display will momentarily flash confirming that your address was stored.

## Function Mode 2: Patch Address (Individual)

Press the MENU button until the Patch Address LED illuminates. The display will show you the current patch setting for channel 1. For example, if channel 1 was set to DMX channel 82, the display would read the following: **1082**. The number 1 in the display indicates channel 1 of the pack. The next three digits indicate the current DMX address for the selected channel.

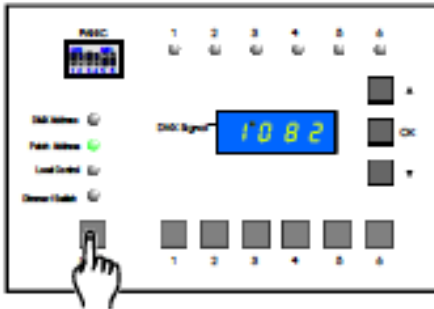

**Note:** If you set a starting DMX address channel in the DMX address option, channel one from the pack will assume that address channel and channels 2 through 6 will automatically be assigned a sequential DMX channel based on the channel 1 address.

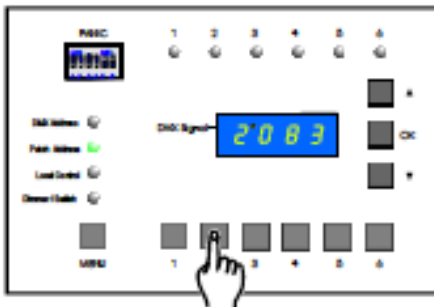

(1) Select a channel button that you want to address. Use the UP/DOWN button to adjust the channel setting. The address can be set anywhere between 001-512.



(3) Press the "OK" button to save your setting. The display will momentarily flash confirming that your patch setting has been stored. Repeat setp1 & 2 to patch additional channels.

## Function Mode 3: Local Control (Manual)

The Local Control option allows for manual control of the packs six channels via the on-board buttons.

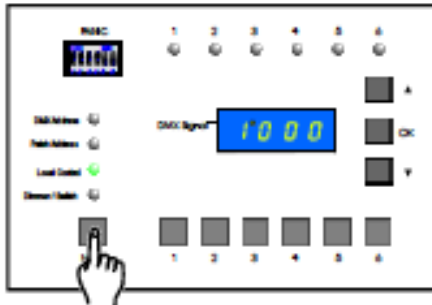

Press the MENU button until the "Local Control" LED illuminates. The display will read **1000**. This means that channel 1 output level is currently set to 0.

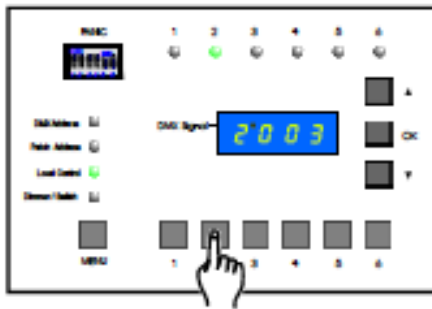

(1) Select the channel that you wish to manually control by selecting from buttons 1-6. Only one channel can be selected at a time.

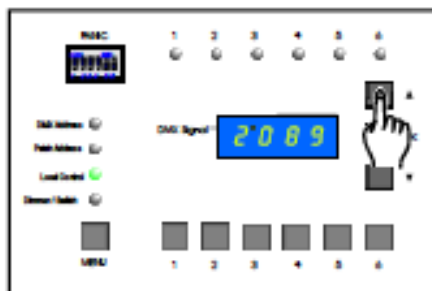

(2) Press the UP/ Down button to adjust the dim value to your desired setting. The dim range is from 000 to 100%.



(3) Press the "OK" button to confirm and save your setting, the display will momentarily flash confirming that your setting was stored. Repeat steps 1, 2 and 3 to manually set additional channel levels and store them. These settings will be stored to memory until you dis-engage the set channels.

## Function Mode 4: Dimmer/Switch

This menu option allows you to set the pack's channels to dim or switch. Each channel can be individually set to do one or the other. When a channel is set to switch, then that channel will activate when the channel level exceeds 50%. When a channel is set to dim, then that channels intensity can manually be adjusted from 0 to 100%.

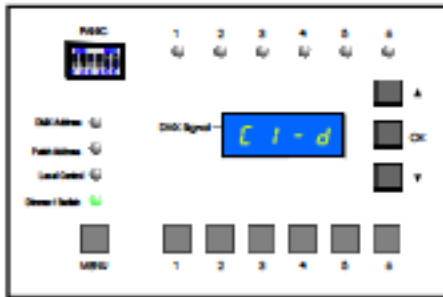

Press the MENU button until the "Dimmer/Switch" LED illuminates. The display will read either "C 1 - d" or "C 1 - s" depending on the current setting. The "C" indicates "Channel". The number that follows is the pack's channel number. The "d" indicates "Dim" and "S" indicates "Switch". In the example to the left, it shows channel 1 is currently set to dim.

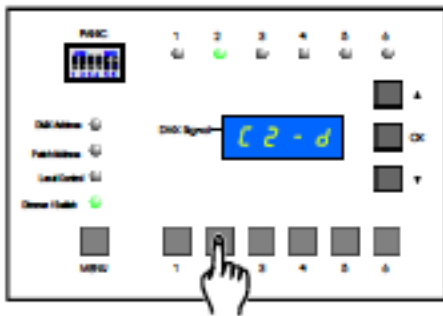

(1) Select the channel that you wish to assign by selecting from buttons 1-6. Only one channel can be assigned at a time.

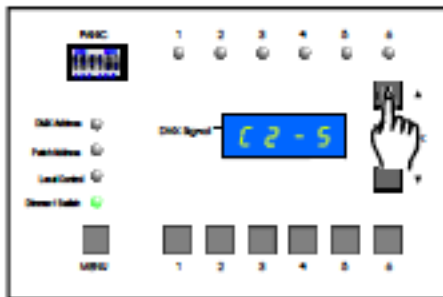

(2) Press the UP/ Down button to change the current setting. d="Dim"/s="Switch"

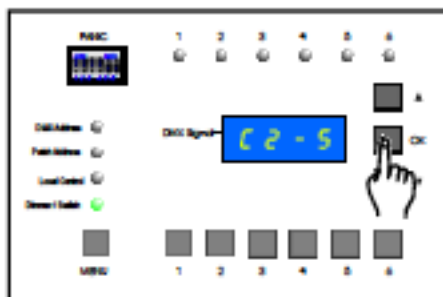

(3) Press "OK" button to confirm and save your setting. The display will momentarily flash confirming that your setting was stored. Repeat steps 1, 2 and 3 to assign additional channels. These settings will be stored to memory.

## PANIC dip-switches 1~6:

The Panic feature allows you to select desired channels, via dip switches 1-6, to be constantly on.

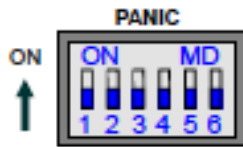

Flip the dip switches of the desired channels to the "ON" position. The selected channels will output 100%. Note: When operating with DMX control, corresponding channels, with dip switches set to "ON", will output 100% while channels with dip switches set to the "OFF" position can be controlled from the DMX console.

## Installation / Mounting

The DP-640B was designed to be mounted or free standing. It is recommended that you use a suitable mounting clamp and safety cable when mounting clamp and rigging to a truss structure. There are two sets of threads on the DP-640B. They are in place for the mounting bracket. Use the bracket knobs and washers to secure the mounting bracket to either side of the pack. For cooling purposes, it is necessary to mount the pack so that air is free to circulate around the dimmer. There should be at least 12 inches of clearance between the pack and anything surrounding it.

## Connections

The DP-640B is supplied with dual 20 Amp Edison plugs attached to 12 gauge line cords. These cords should be connected to a service capable of supplying 20 amps per line cord and be protected by a properly sized main circuit breaker. Lamp loads should be plugged into the dual 20 Amp Edison sockets which are supplied on the face of the pack. 3 & 5 pin XLR's are supplied for the DMX input and output of the data link. Connect out of the DMX controller or previous fixture in line and into the input of the DP-640B. Connect out of the DP-640B and into the input of next pack or fixture in line. It is recommended that the last pack or fixture in line include a DMX terminator into the output. A DMX terminator consists of a 120 ohm, 1/4 watt resistor soldered across pins 2 & 3 of a standard 3 or 5 pin XLR connector.

## TROUBLE SHOOTING

### **No Power to the pack:**

Disconnect the main power line cord. Reconnect the line cord to ensure proper connection. If the problem still persists, check the building service panel and make sure the circuit breakers are in the ON position.

### **No Channel output:**

Disconnect the main power line cords. Check the circuit breakers to ensure they are in the ON position. Reconnect line cords. If controlling via DMX, ensure that you are receiving DMX signal at the pack. Indicator in the display should be flashing when signal is present. If signal is not present, check the XLR connections from console or previous fixture in line. If problem still persists, replace XLR cable between previous device and pack and try again.

### **Undesired 100% channel switch output:**

Flip all "PANIC" dip switches to the OFF position. If problem still persists, check the "LOCAL CONTROL" settings and reset channels by pressing the corresponding channel button two times so that the channel LED turns OFF. Then press the "OK" Button store the settings.



## MAINTENANCE



**C A U T I O N**

**Disconnect power before performing any maintenance.**

### MAINTENANCE

Regular inspections are recommended to insure proper function and extended life. There are no user serviceable parts inside this device, please refer all other service issues to an authorized Elation service technician. Should you need any spare parts, please order genuine parts from your local Elation dealer.

Please refer to the following points during routine inspections:

- A detailed electric check by an approved electrical engineer every three months, to ensure circuit contacts are in good condition and prevent overheating.
- Be sure all screws and fasteners are securely tightened at all times. Loose screws may fall out during normal operation resulting in damage or injury.
- Check for any deformations on the housing, rigging hardware and rigging points. Deformations in the housing could allow for dust to enter into the device. Damaged rigging points or unsecured rigging could cause the device to fall and seriously injure a person(s).
- Electric power supply cables must not show any damage, material fatigue or sediments. Never remove the ground prong from the power cable.

# TECHNICAL SPECIFICATIONS

Power Input .....	2x20A, AC 120V~50/60Hz
Line cord.....	2x12AGWx3C VW-1 105 C
Load.....	2400W Channels 1~3, 2400W Channels 4~6
MCB (x2) .....	20A Each
Dimensions .....	19.7"x6.57"x3.66"(500x167x93mm)
Weight(approx.) .....	7.5lbs.(3.4 kg)

## Dimensions in detail: (mm)

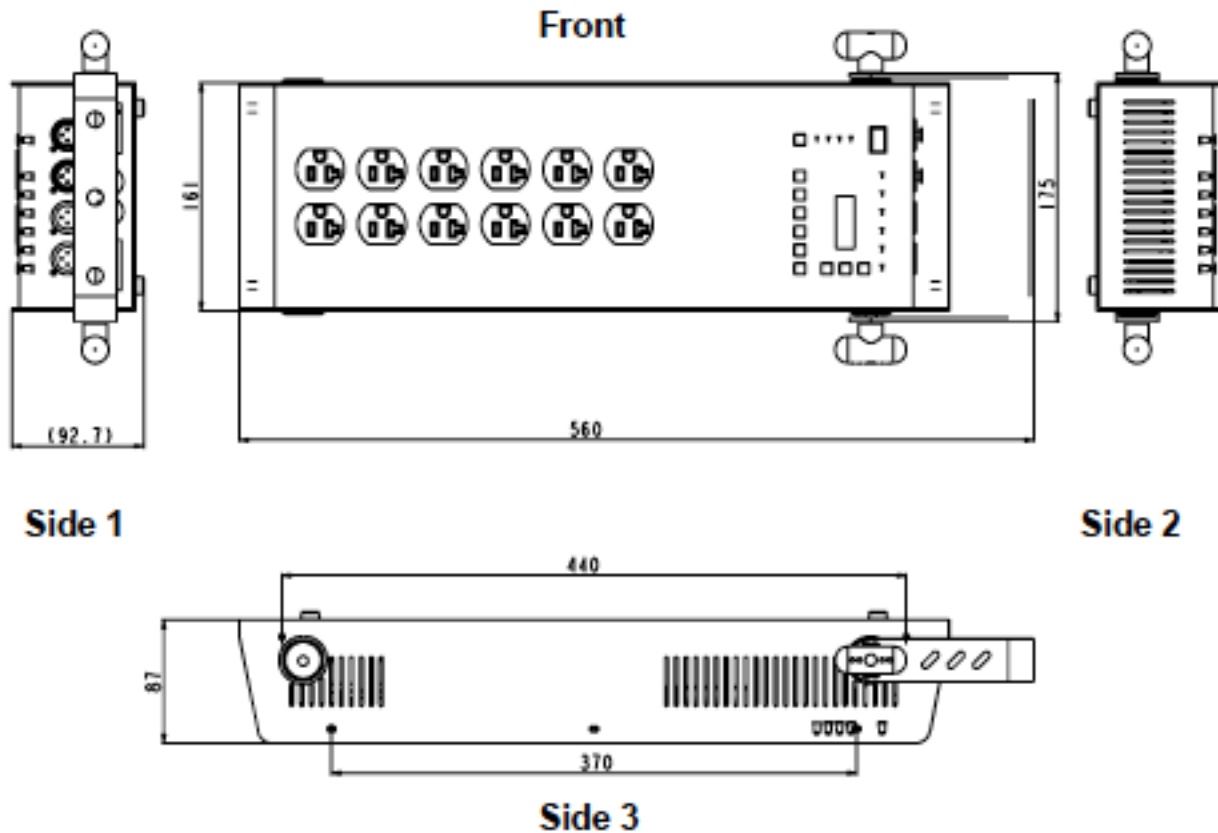

Please Note: Specifications and improvements in the design of this unit and this manual are subject to change without any prior written notice.

## OPTIONAL ACCESSORIES

ORDER CODE	ITEM
NARROW CLAMP	Narrow Style Clamp
AC3PDMX5PRO	5 ft. (1.5m) 3pin PRO DMX Cable
AC5PDMX5PRO	5 ft. (1.5m) 5pin PRO DMX Cable
	Additional Cable Lengths Available

